

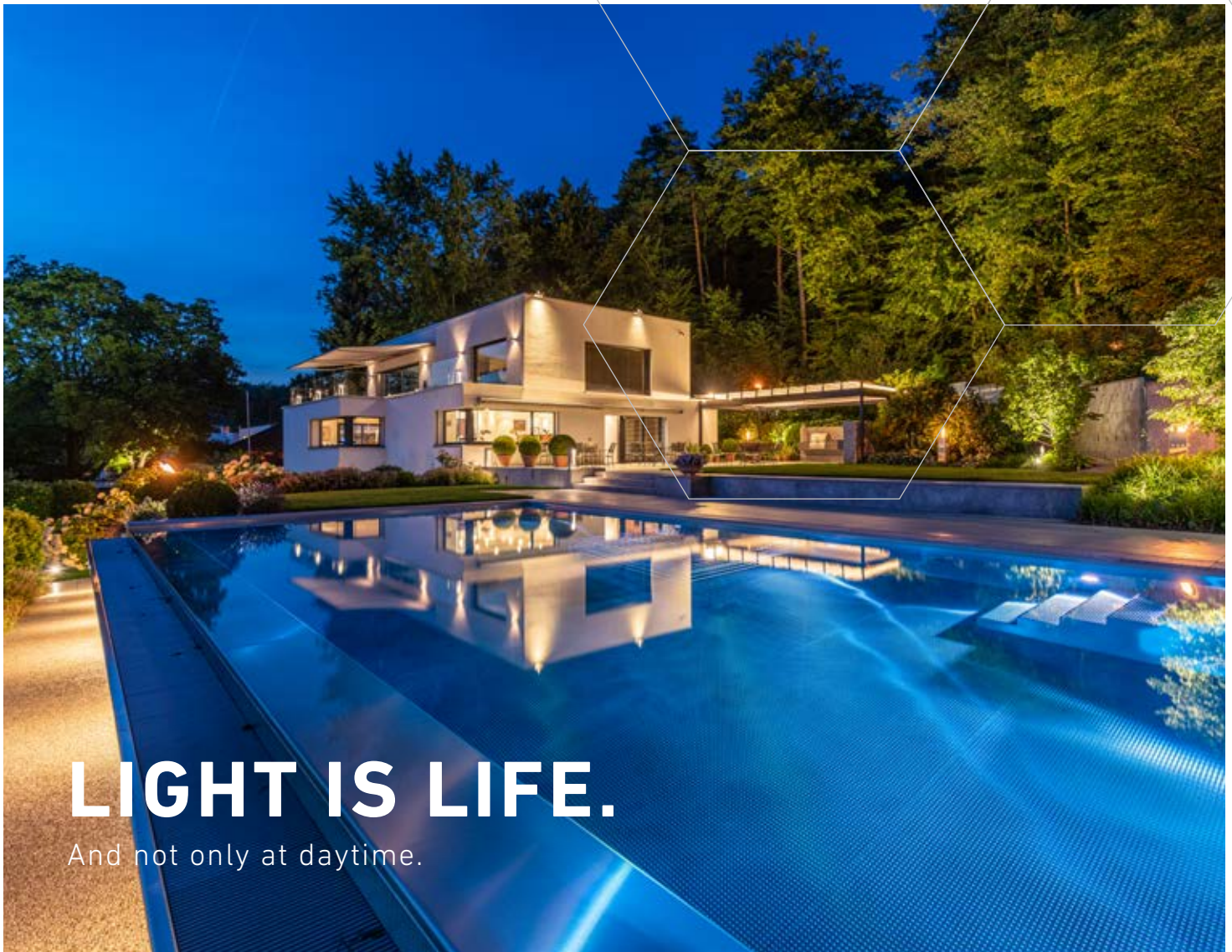

**LIGHTING FOR THE
WORLD'S MOST
BEAUTIFUL GARDENS.**



LUMINAIRES WITH NO COMPROMISES.



LIGHT IS LIFE.

And not only at daytime.

It's true that we can achieve a great deal. But there's one thing we don't want to (and cannot) do – compete with the effects of natural light. The multifaceted nature of daylight simply cannot be surpassed ... but it can certainly be supplemented. When the day draws to an end, staub designlight's time truly begins. Our lighting concepts let you experience your garden in a completely new way ... by helping to enliven the "world outside" after sunset.

For more than 20 years, staub designlight has represented the epitome of atmospherically illuminated gardens and pools, providing convincing arguments for underlining the beautiful and accentuating the valuable. staub designlight helps to structure your garden landscapes, provides extra orientation and safety on paths and surfaces and creates pleasing axes of light. We turn plants into garden art, put architecture in a favourable light and create both romantic and spectacular effects.

Light is life. Light is atmosphere. We strive to ensure this every day.

- 10 -

THINGS
that are
important to
us and our
customers.

STAUB DESIGNLIGHT IS

LIGHTING THE WAY TO THE WORLD'S MOST BEAUTIFUL GARDENS

NO.

1

STAUB DESIGNLIGHT. AN INSTITUTION IN THE FIELD OF OUTDOOR LIGHTING FOR OVER 20 YEARS.

The joy of creative lighting meets Swiss perfection – that is staub designlight. Our passion for beautiful gardens is exceeded only by the uncompromising quality of our products.

The staub designlight design team is on the same wavelength as the committed garden designers and landscape architects they serve. This partnership illuminates the way to stunning lighting concepts that delight garden owners all over the world. staub designlight brings light to the “outside world” – from private gardens and commercial exteriors to public facilities, all our projects are characterised by the same high standards!

- Over 20 years of experience
- Uncompromising Swiss quality
- References all over the world
- Dedicated competence team
- Long-term customer-partner relationships

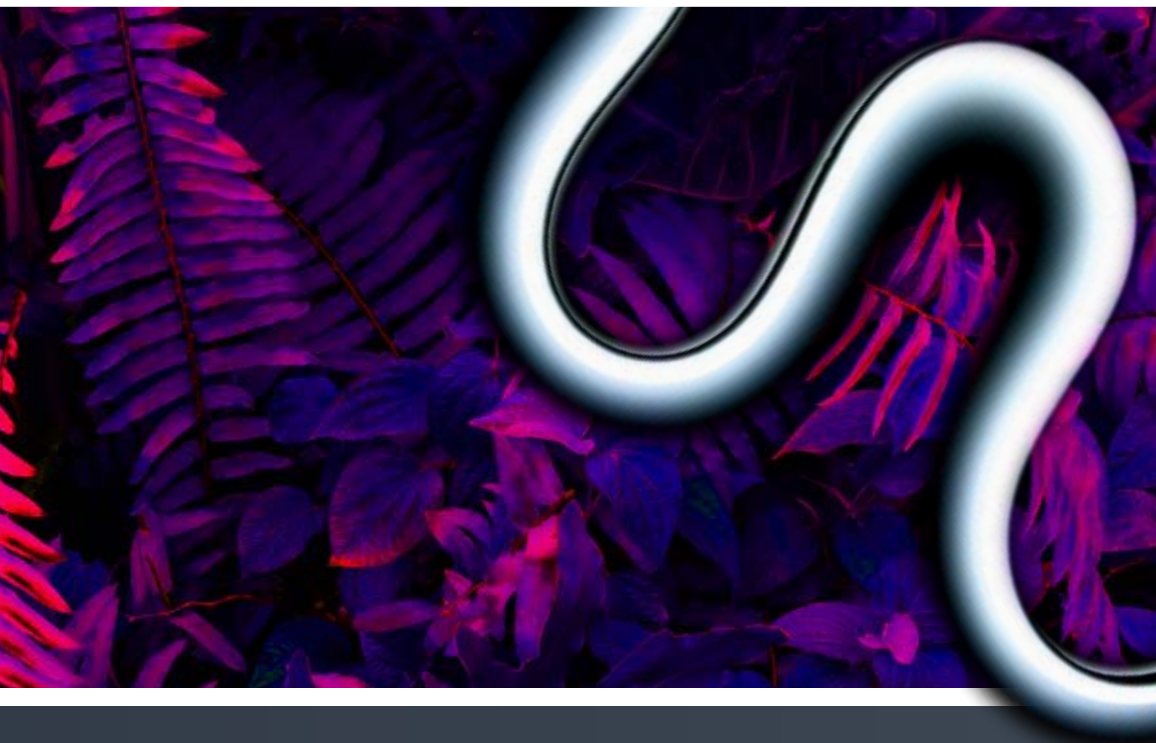

Outdoor installations only come to life in the right light.
Create your dream garden



A garden artist needs the right tools. Try painting with light!



STAUB DESIGNLIGHT STANDS FOR

WATER-TIGHTNESS

NO.

-2-



IP 68-
TESTED

100 %
waterproof

HIGHEST STANDARDS FOR FLAWLESS FUNCTIONALITY AND LONG-TERM DURABILITY.

The absolute reliability of our luminaires is a maxim for us and our customers. For this reason, we never compromise when it comes to ensuring the water-tightness of our products. All staub designlight luminaires are suitable for use above and under water at all light intensities – without exception! Whether withstanding tropical rainstorms in outdoor areas or ensuring years of trouble-free lighting for pools – staub designlight lights are tested in accordance with the IP 68 industry standard and are therefore guaranteed waterproof!

- IP 68-tested – highest industrial standard
- Guaranteed permanently waterproof
- Creative effects through underwater lighting
- Trouble-free operation in all seasons
- All cable connections are sealed watertight

STAUB DESIGNLIGHT STANDS FOR

LONGEVITY



VIRTUALLY ALL OF OUR LUMINAIRES THAT WERE INSTALLED DURING THE LAST 20 YEARS ARE STILL IN USE TODAY.

In order to install luminaires outdoors – whether in the ground, in brickwork or under water – there must be no weak points in terms of the material quality and construction. As the market leader, we provide a 7-year warranty on all staub designlight luminaires. This is maximum quality – made in Switzerland!

The technical advantages are obvious, however the human ones are equally valuable, i.e. no complaints from your customers!

- 7-year warranty on all staub designlight luminaires
- Designed in stainless steel
- Made in Switzerland
- Extremely long service life
- Permanently satisfied customers



STAUB DESIGNLIGHT STANDS FOR

MODULARITY

NO.

-4-

OUR MODULAR SYSTEM MEANS NO LIMITS FOR YOUR IDEAS.

The construction, extension and conversion of sophisticated outdoor installations is the bread and butter of garden and landscape designers around the world. When adapting gardens to meet the wishes of their owners, lighting is often a central theme. So it's just as well that the staub designlight modular system is based on a virtually unlimited modular design.

Most of our luminaires can be combined with each other. Their easy assembly and timelessly aesthetic designs make changes and expansions a pleasure for everyone involved.

- Sophisticated modular technology
- Flexible expansion through modular system
- Extensive range of luminaires
- Almost all components can be combined
- Availability guarantee for luminaire models and components

STAUB DESIGNLIGHT STANDS FOR

SIMPLICITY

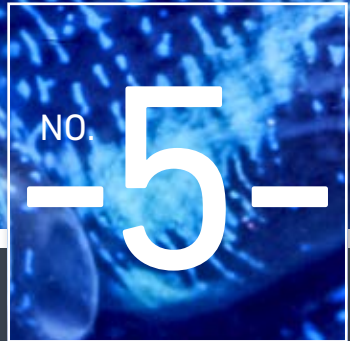
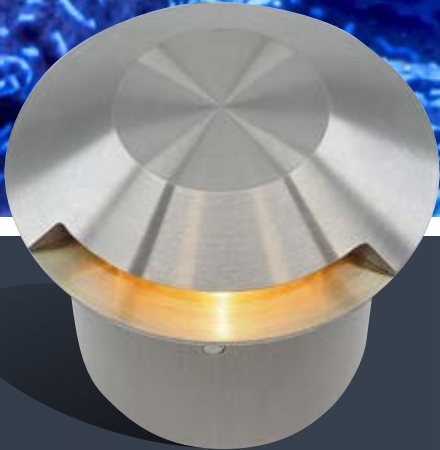

OUR TECHNOLOGY MAKES LIGHT WORK OF YOUR WORKLOAD ... AND YOUR CUSTOMERS HAPPY.

We want our partners to be able to concentrate on the core element of their work: garden design! Which is why all staub designlight luminaire sets are supplied ready for connection. Thanks to our 12/24V low-voltage system, installation takes no time at all.

The future-oriented, easy operation of our systems is the gift that keeps giving – the latest generation of wireless remote controls for iPhone, iPad, Android or PC puts your customers in total control of multi-faceted lighting scenarios.

- “Clamp and Light” technology
- All luminaires are supplied ready for connection
- 12/24 V low voltage for easy installation
- Precisely calculated cables for optimum light intensity
- Future-proof wireless remote controls

STAUB DESIGNLIGHT STANDS FOR

DESIGN



NO.

-6-

■ TIMELESS, PURIST AESTHETICS FOR “ETERNALLY” BEAUTIFUL GARDENS.

“Well-designed products should never draw attention to themselves”. Staub Designlight luminaires have always embodied this maxim to perfection: timelessly elegant design meets elegant yet discreet materials – for a high-quality overall aesthetic that will continue to delight for a lifetime. Whether for minimalist or opulent garden architecture, whether for sculptural museums or luxuriant water landscapes – Staub Designlight products blend inconspicuously and yet confidently into your garden design.

- Functional design
- Timelessly modern
- Made of high-quality stainless steel
- Elegant surface finishes
- Stylish integration into all outdoor installations

STAUB DESIGNLIGHT STANDS FOR

SAFETY



SWISS QUALITY
PRODUCT
"THE ORIGINAL"

PROFESSIONAL LIGHTING TECHNOLOGY – MAXIMUM SAFETY.

We manufacture luminaires for demanding outdoor installations. And this focus can also be seen in our products: staub designlight is the epitome of high quality and safety – and not just in Switzerland. From in-house development and production to expert support for your planning tasks, we consistently live our philosophy of providing maximum added value for our customers. From highly qualified and highly motivated consulting to comprehensive after-sales services, our customers (and their customers) are always in safe hands with staub designlight!

- Exhaustively tried-and-tested technology
- Safety in every detail: e.g., via integrated martens protection
- All luminaire sets are optimally dimensioned in terms of voltage
- IP-rated and tested waterproof luminaires

STAUB DESIGNLIGHT STANDS FOR

INDIVIDUALISM

NO.

-8-



OUR LUMINAIRES UNDERLINE THE UNIQUENESS OF YOUR GARDENS.

Gardens have personalities. Just like their owners. And just like their planners. Our range of luminaires is designed to emphasise the unique character of outdoor installations in a discreet but unmistakable way. With luminaires that subordinate themselves to your ideas thanks to unobtrusive aesthetics, but whose effect impressively highlights the quality of your work.

- Discreet, yet distinctive design
- Blends in perfectly with all kinds of garden architecture
- Can be combined with all kinds of designs
- Limitless applications

STAUB DESIGNLIGHT STANDS FOR

SERVICE



NO. **9**

OUTSTANDING PRODUCTS ARE OUR DUTY – HIGH-QUALITY SERVICE IS OUR PLEASURE.

With us, good service begins as soon as you need us – even as early as the project planning phase for your outdoor installations. Our experts – brought on board ahead of time – will be delighted to help you find the ideal lighting concept for your garden plans.

The efficient interactions within our team ensure your customers will be thrilled – for example, when the goal is to create an atmospheric “outdoor living room” after sunset. And we also believe that good service never ends! Therefore, we remain your obliging and competent partner for all “after-sales” matters – and are even happy to assist you on site!

- Support in planning and execution
- On-site consulting at the end customer’s location
- Support for your marketing activities
- Individual special designs on request
- Special solutions in corrosion-resistant V4A steel

STAUB DESIGNLIGHT STANDS FOR

INNOVATION

NO. **10**

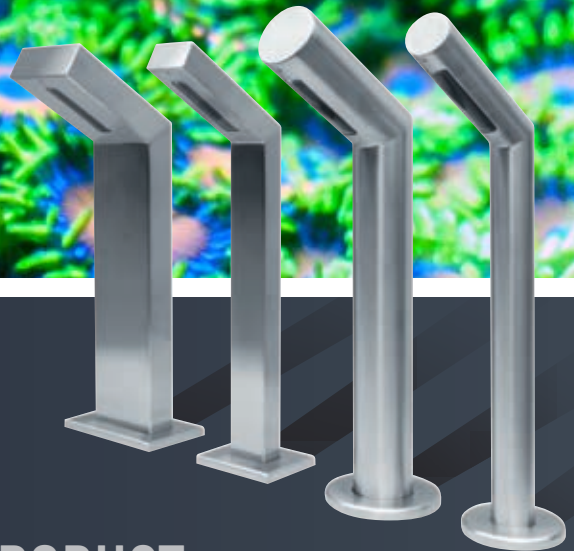

A SUSTAINABLE PRODUCT RANGE ALSO REQUIRES CONTINUOUS FURTHER DEVELOPMENT.

Aligning our product range to meet your requirements and satisfy the wishes of even the most demanding end customers continuously motivates us to innovate and improve. staub designlight has been setting standards in the outdoor lighting segment for over 20 years – and will continue to do so!

We always have our ear to the ground in the market and keep a watchful eye on new garden trends and themes. Which is why the new additions to our product range provide fresh inspiration for many creative applications – and let you offer your customers new opportunities to experience their outdoor areas with renewed fascination!

- Innovation leaders for over 20 years
- Regular product launches and upgrades
- State-of-the-art HP-LED and RGBW multicolour technology
- Fresh ideas for your garden planning
- New arguments to inspire your customers

FULLY IN THE LIMELIGHT – WELCOME TO OUR HIGHLIGHTS.

Personalise your garden like never before – prepare to be inspired!



FLEXIBLE LUMINAIRES
Megaflex **P. 26 / 27**



NEW SHAPES
Waveline **from P. 78**



NEW STANDING
Stilys **P. 74 / 75**

Light creates lines.
Unleash your creativity!



NEW COLOURS
P. 16 / 17

Many of our spotlights are now available in three elegant colours: stainless steel, stainless steel Retro Bronze and stainless steel SDL-Black.

CONTENTS

SURFACE-
MOUNTED
LUMINAIRES

from P. 8

RECESSED
LUMINAIRES

from P. 28

PATH
LIGHTING

from P. 60

LINEAR
LUMINAIRES

from P. 76

POOL
LIGHTING

from P. 90

ACCESSORIES

from P. 98

SERVICE

from P. 122



From left to right: Roger Gosztola (Head of Sales), Roger Schuler (Service & Consulting), Daniel Wirth (Executive Board), Jürg Furrer (Production Manager)

STAUB DESIGNLIGHT STANDS FOR MAXIMUM QUALITY.

Uncompromisingly reliability for over 20 years – perfection made in Switzerland.

Quality begins with a train of thought. In other words, it begins with people – with the entire staub designlight team. We regard the quality of our products not only as a measurable and testable mathematical quantity, but also as our clearly defined mission. Maximum reliability for maximum satisfaction of our partners and their customers – this is our promise, which guides our actions and creates the high standards against which we measure ourselves every single day! Our customers, in turn, know exactly what staub

designlight delivers. And that although top quality comes at a price, investing in the best always pays off in the long term.

This is repeatedly confirmed by enthusiastic garden owners from all over the world, even after decades. Trouble-free operation over 20 years – this is what staub designlight means by “lived sustainability”!

You can continue to rely on us long into the future – this is our promise!



IN-HOUSE PRODUCTION

Swiss
quality product



Almost all of our
luminaires remain in
use after 20 years.
This is what we mean by
"staub designlight
quality".



IP 68- TESTED

100 % waterproof

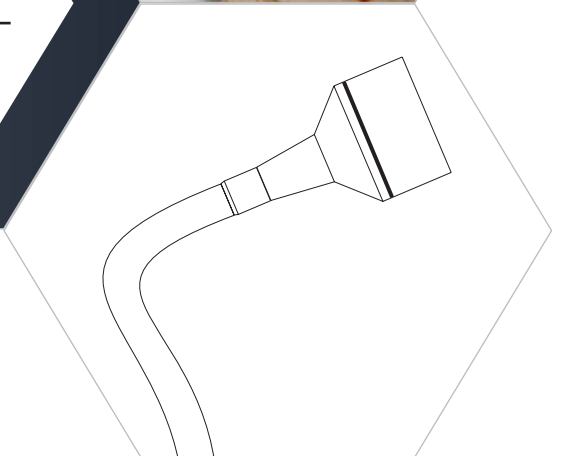

THE ARCHITECTURE OF LIGHT.

IP 68-
TESTED

100% waterproof

Maxiflex
P. 24/25

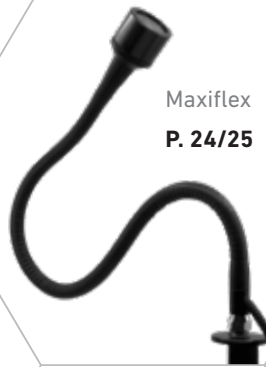

Maxispot
P. 12/13



Megaspot
P. 14/15



Ultraspot
P. 10/11



Unlimited application possibilities in outdoor areas, above or under water

Angle Spot / Plus / Effect
P. 30-37

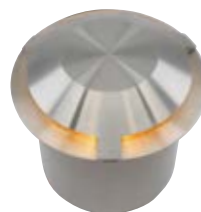

Superspot
P. 44/45



Superspot Effect
P. 46/47



Superspot Mini / Effect
P. 40-43



IN-HOUSE
PRODUCTION

Swiss
quality product



Ultraflex
P. 22/23



Superspot Compact / Effect
P. 50-53



Gigaspot
P. 18/19



Megaflex
P. 26/27



Most of our luminaires can be combined with each other

Spotlight,
Flat Light,
Flash Light
P. 20/21



Microspot
P. 38/39





Honeycomb Spot /
Super
P. 56-59



Linear Line Opal
P. 88/89



Tube Light
P. 64/65

7-year warranty
on all staub design-
light luminaires



Available at short
notice individually or
as customised light
chains or star sets



Down Light
P. 62/63



Cosmospot
P. 54/55



Topspot
P. 72/73



Linear Line Micro
P. 86/87

Quick and easy
installation

Very long life, low
power consumption
and low heat
generation



Waveline
P. 78/79



Stilys
P. 74/75

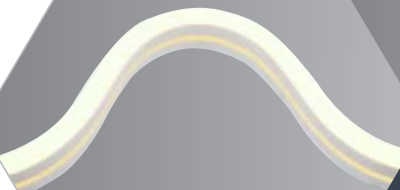

Curveline
P. 84/85



Waveline EDGE
P. 82/83

Unrivalled HP-LED
modular technology
with integrated
temperature control



Transformers
P. 102



Block Light
P. 92/93

Demo case
P. 130-133



Megaspot Pool
P. 94/95

Perfect design
meets perfect
quality – in beautiful
and rustproof
stainless steel





SURFACE- MOUNTED LUMINAIRES

Ultraspot

Maxispot

Megaspot

Gigaspot

P. 10 / 11

P. 12 / 13

P. 14 / 15

P. 18 / 19

Spotlight / Flat Light / Flash Light

Ultraflex

Maxiflex

Megaflex

P. 20 / 21

P. 22 / 23

P. 24 / 25

P. 26 / 27

ULTRASPOT

INVISIBLE SUPERSTAR

In a nutshell: Impressively compact! There isn't much else to say ...
The Ultraspot is ultra-compact, extremely efficient – and really, really bright.



Ultraspot stainless steel

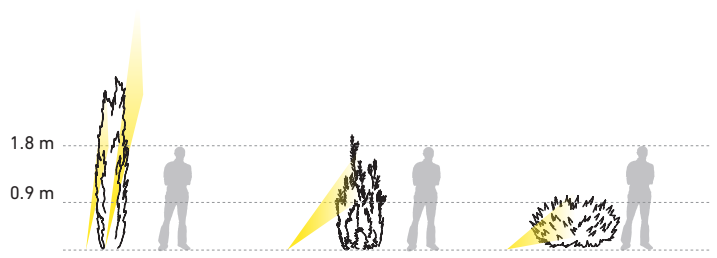
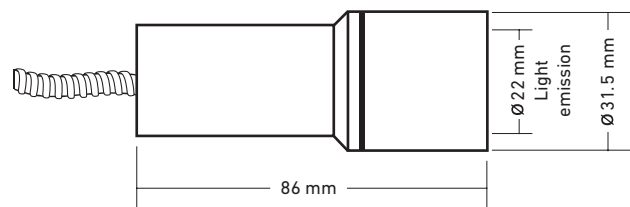

1 W / 10°	1 W / 20°	1 W / 30°
Light cone: ø approx. 0.3 m Beam range: approx. 2.5 m	Light cone: ø approx. 0.4 m Beam range: approx. 1.5 m	Light cone: ø approx. 0.6 m Beam range: approx. 1 m



SDL-Black



Retro Bronze

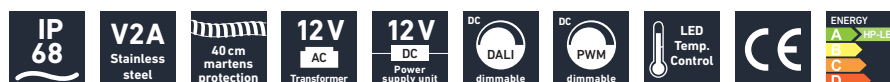

Standard version

Voltage	12 V AC/DC
LED output	1 W
LED colour	warm white 2700 K
Beam angle	10°, 20°, 30°, 44° x 12°
Light output	58 lm
Apparent power	2.5 W

Special design

LED colour	warm white 3000 K cool white 6000 K
Lighting accessories (optional)	Warm-light filter, frosted glass, honeycomb anti-glare louvre
Cable length and martens protection can be customised.	

ULTRASPOT HP-LED, 12 V AC/DC	Stainless steel	SDL-Black	Retro Bronze
1 W, 10°, warm white	20.162011	20.800000	20.900000
1 W, 20°, warm white	20.162012	20.800001	20.900001
1 W, 30°, warm white	20.162013	20.800002	20.900002
1 W, 44° x 12°, warm white	20.162015	20.800003	20.900003

A data sheet with detailed lighting data for each product is available to download from our website.
Subject to change without notice! Please observe the safety regulations and our terms and conditions!



The Ultraspot:
Skilfully adds discreet lighting accents to every installation.

MOUNTING ACCESSORIES
(P. 98 – 121)
optionally available

Ground spike, luminaire holder, base plate, dowel, tubular glare guard, square ground tube

Ground spike

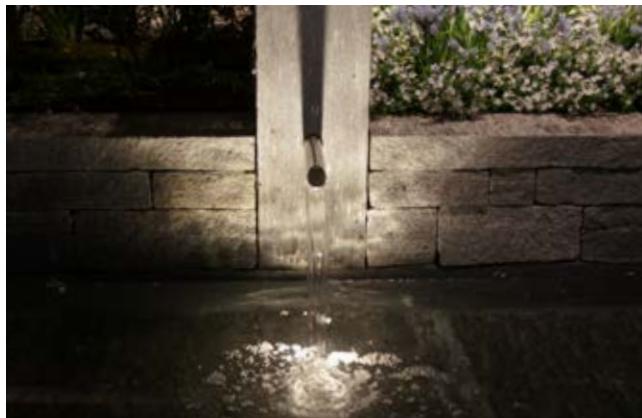

Ultraspot, ideal lighting for fountains

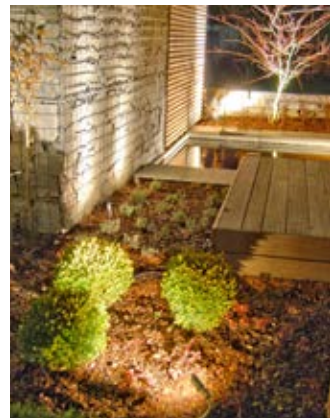

Ultraspot, luminaire holder 40 mm, attached to granite stele with brass dowel

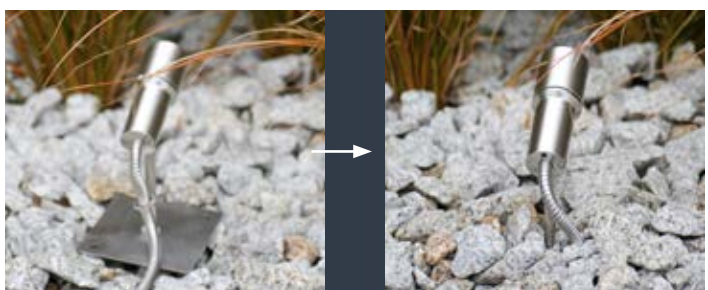

Ultraspot, luminaire holder 115 mm with base plate

MAXISPOT

OUR PROVEN ALL-ROUNDER

A popular spotlight for a wide variety of locations – puts installations in the best light and creates spectacular effects in outdoor spaces.

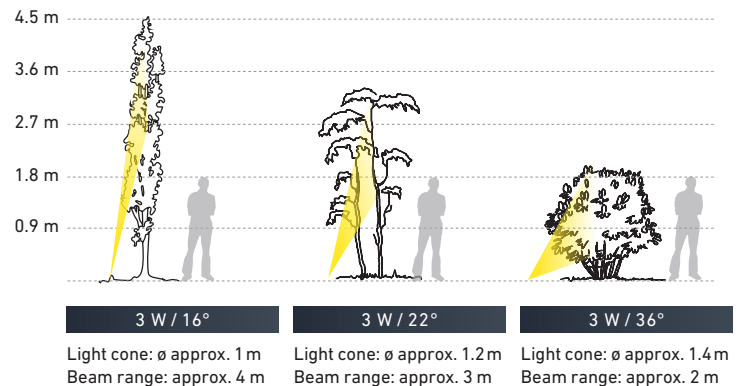
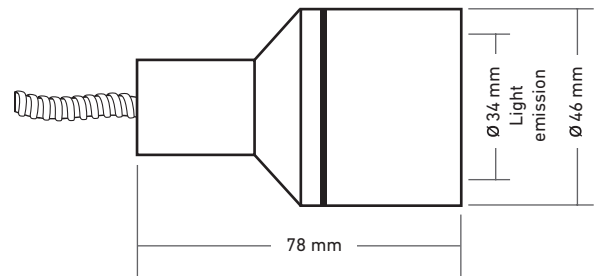

Maxispot stainless steel



LED MODULE
replaceable

Standard version

Voltage	12 V AC/DC	(warm white)
Current	0.35 A	(RGBW)
LED output	3 W	(warm white)
	4 W	(RGBW)
LED colour	warm white	2700 K
	RGBW	4000 K
Beam angle	16°, 22°, 36°, 34° x 17°	
Light output	304 lm	(warm white)
Apparent power	5.5 W	(warm white)
	7 W	(RGBW)

Special design

LED colour	warm white	3000 K
	cool white	6500 K
Material	V4A stainless steel	
Lighting accessories (optional)	Warm-light filter, frosted glass, honeycomb anti-glare louvre, diverse colour filters	

Cable length and martens protection can be customised.

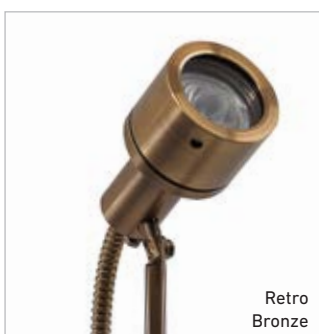

MAXISPOT HP-LED, 12 V AC/DC	V2A stainless steel	SDL-Black	Retro Bronze	V4A stainless steel
3 W, 16°, warm white	20.448055	20.800010	20.900010	20.358055
3 W, 22°, warm white	20.448052	20.800011	20.900011	20.358052
3 W, 36°, warm white	20.448056	20.800012	20.900012	20.358056
3 W, 34° x 17°, warm white	20.448057	20.800013	20.900013	20.358057
MAXISPOT RGBW, 0.35 A	V2A stainless steel	SDL-Black	Retro Bronze	V4A stainless steel
4 W, 16°, RGBW	20.430010	20.830010	20.930010	20.430020
4 W, 22°, RGBW	20.430011	20.830011	20.930011	20.430021
4 W, 36°, RGBW	20.430012	20.830012	20.930012	20.430022
4 W, 34° x 17°, RGBW	20.430013	20.830013	20.930013	20.430023

Detailed light technical data and light technical data for all products is available to download from our website. Subject to change without notice! Please observe the safety regulations and our terms and conditions!

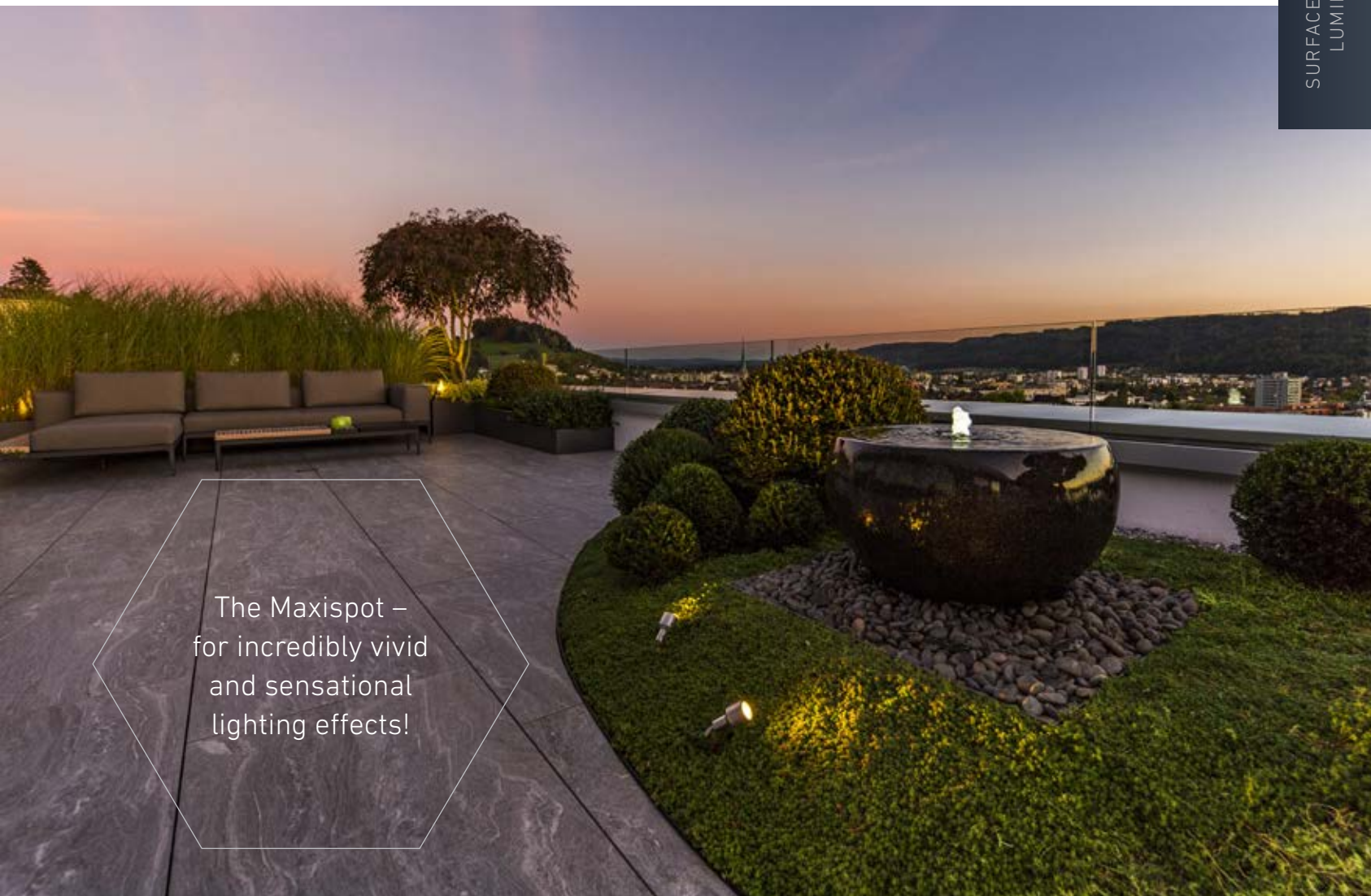

The Maxispot –
for incredibly vivid
and sensational
lighting effects!

**MOUNTING
ACCESSORIES**
(P. 98 – 121)
optionally available

Ground spike, luminaire holder,
base plate, dowel, tubular glare
guard, square ground tube



Maxispot with ground spike



Fountain lighting with Maxispot



Maxispot creates an interesting interplay of light and shadows – this is particularly effective when combined with water features



Maxispot including tubular glare guard and ground spike

MEGASPOT

SHINES FAR AND WIDE

Mega radiance! If you want to illuminate a particularly high or wide area with a compact luminaire that can also produce monochrome light or changing colours, this luminaire is simply spot on.

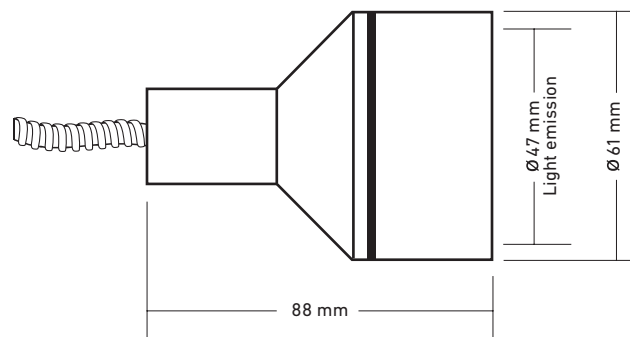

LED MODULE
replaceable



Standard version

Voltage	12 V AC/DC	(warm white)
Current	0.4 A	(RGBW)
LED output	9 W	(warm white)
	12 W	(RGBW)
LED colour	warm white	2700 K
	RGBW	4000 K
Beam angle	14°, 20°, 40°	
Light output	745 lm	(warm white)
Apparent power	11.5 W	(warm white)
	15 W	(RGBW)

Special design

LED colour	warm white	3000 K
	cool white	6200 K
Material	V4A stainless steel	
Lighting accessories (optional)	Warm-light filter, frosted glass, honeycomb anti-glare louvre	
Cable length and martens protection can be customised.		

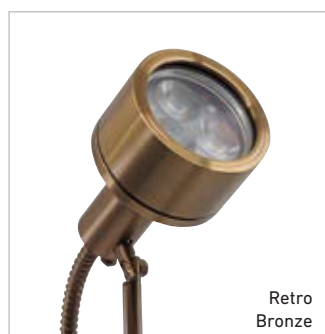

MEGASPOT HP-LED, 12 V AC/DC	V2A stainless steel	SDL-Black	Retro Bronze	V4A stainless steel
9 W, 14°, warm white	20.166014	20.800020	20.900020	20.356014
9 W, 20°, warm white	20.166015	20.800021	20.900021	20.356015
9 W, 40°, warm white	20.166008	20.800022	20.900022	20.356008
MEGASPOT RGBW, 0.4 A	V2A stainless steel	SDL-Black	Retro Bronze	V4A stainless steel
12 W, 14°, RGBW	20.166022	20.800023	20.900023	20.356022
12 W, 20°, RGBW	20.166023	20.800024	20.900024	20.356023
12 W, 40°, RGBW	20.166016	20.800025	20.900025	20.356016

A data sheet with detailed lighting data for each product is available to download from our website.
Subject to change without notice! Please observe the safety regulations and our terms and conditions!

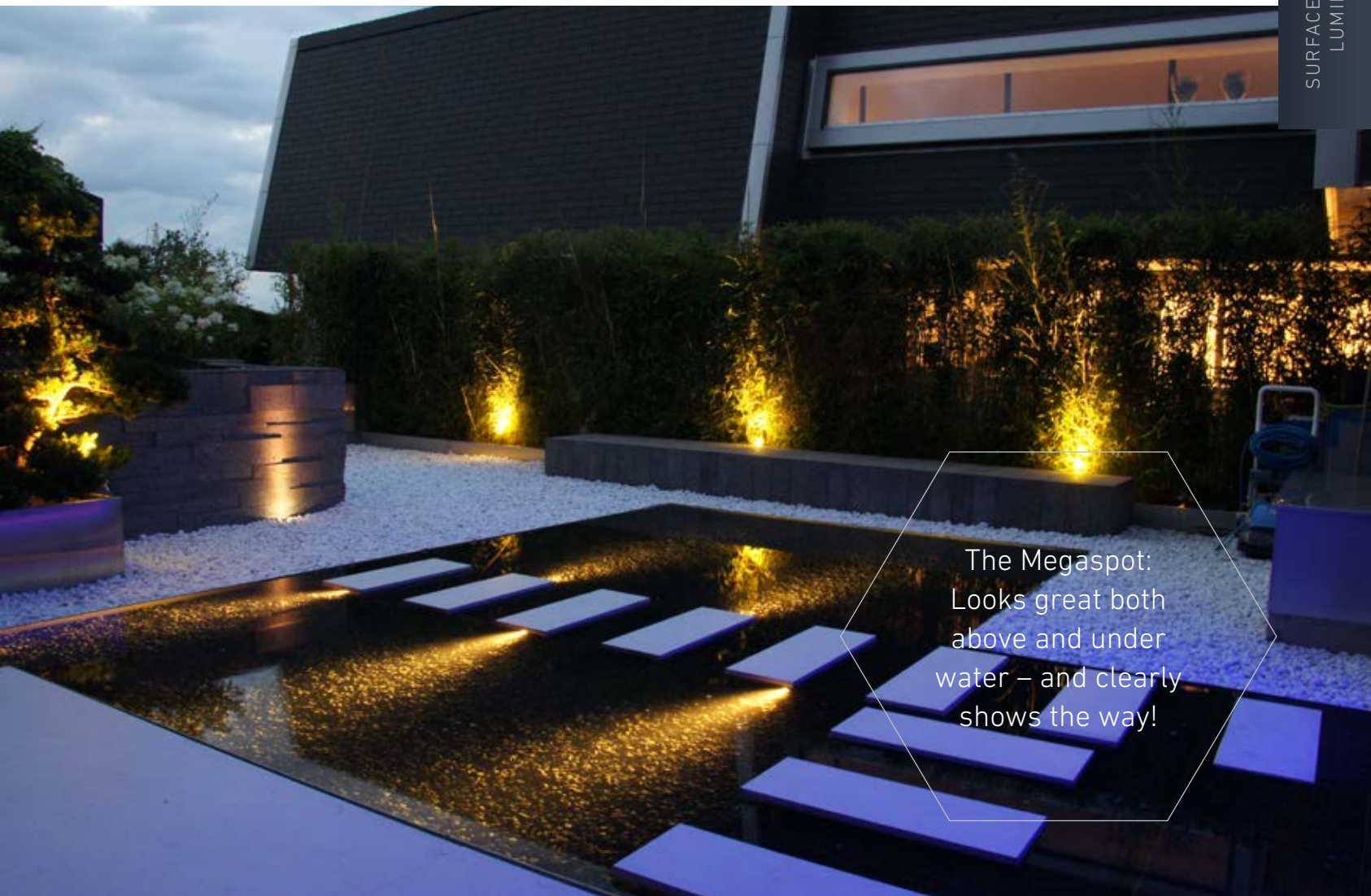

The Megaspot:
Looks great both
above and under
water – and clearly
shows the way!

MOUNTING ACCESSORIES
(P. 98 – 121)
optionally available

Ground spike, luminaire holder, base plate, dowel, tubular glare guard, square ground tube

Tubular glare guard, stainless steel

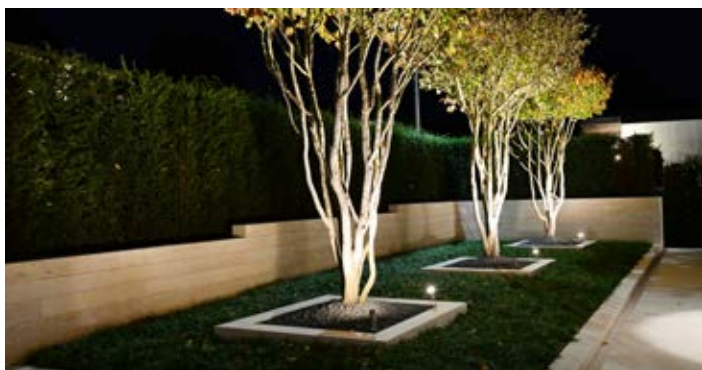

Megaspot – offers an extremely wide range of lighting possibilities

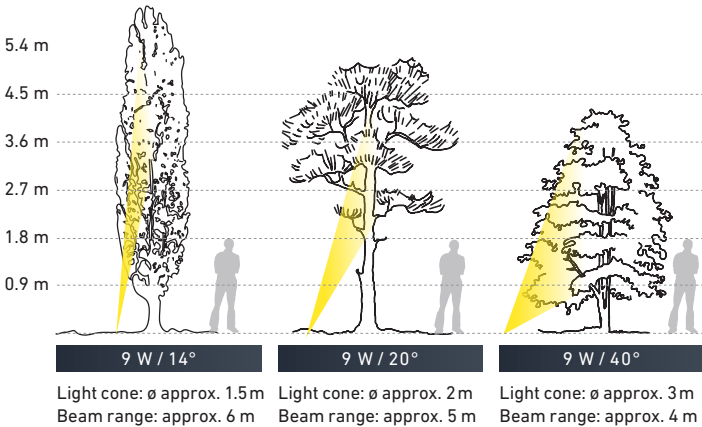

Megaspot with ground spike



Megaspot including tubular glare guard

TIMELESSLY BEAUTIFUL COLOURS

FOR EVEN MORE INDIVIDUAL GARDEN DESIGNS.

Many of our spotlights are available in **three elegant colours:**

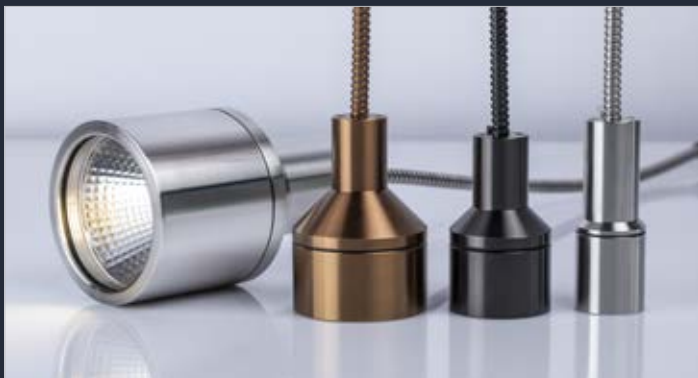
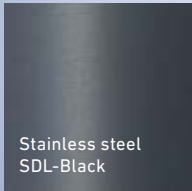
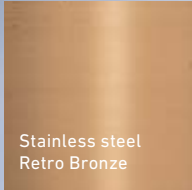
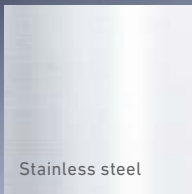

The Spot series by staub designlight sets the tone in the world's most beautiful gardens. At the request of countless garden designers, we can supply these icons of illumination in three timelessly elegant housing colours. staub designlight: perfect design meets perfect quality.



GIGASPOT

THE ULTIMATE LIGHT POWERHOUSE

Incredibly powerful – and yet so compact it can be used anywhere.

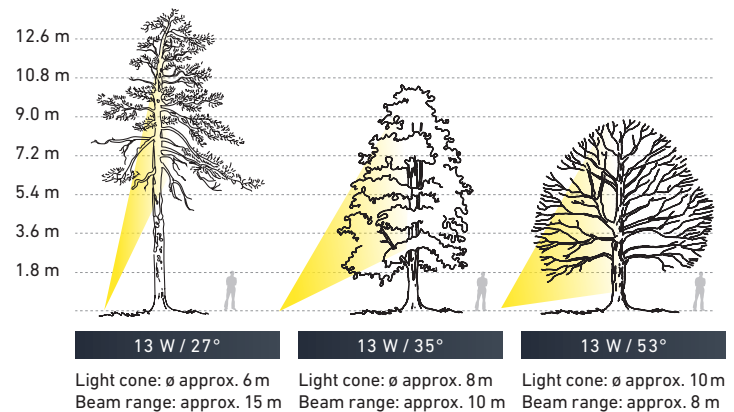
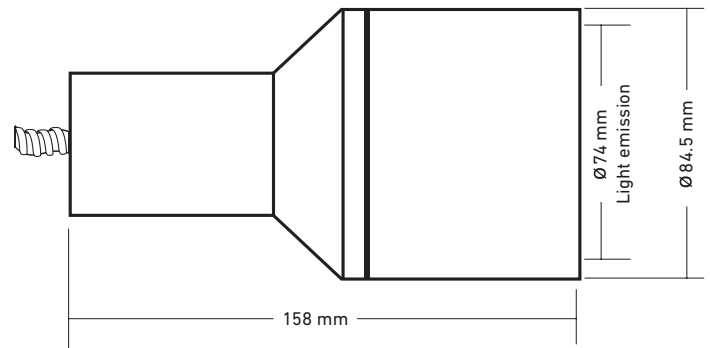

Standard version

Voltage	12 V DC
LED output	13 W
LED colour	warm white 2700 K
Beam angle	27°, 35°, 53°
Light output	1273 lm
Apparent power	18 W

Special design

Lighting accessories (optional)	Warm-light filter, frosted glass, honeycomb anti-glare louvre
Cable length and martens protection can be customised.	

GIGASPOT HP-LED, 12 V DC	Stainless steel	SDL-Black	Retro Bronze
13 W, 27°, warm white	20.167000	20.800030	20.900030
13 W, 35°, warm white	20.167001	20.800031	20.900031
13 W, 53°, warm white	20.167004	20.800032	20.900032

A data sheet with detailed lighting data for each product is available to download from our website.
Subject to change without notice! Please observe the safety regulations and our terms and conditions!



The Gigaspot:
Our star for the big stage and spectacular performances.

MOUNTING ACCESSORIES

(P. 98 – 121)

optionally available

Ground spike, luminaire holder with lock toothing, base plate, dowel, tubular glare guard

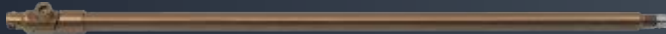

Luminaire holder, Retro Bronze, with lock toothing



Gigaspot, tree lighting



Gigaspot, tree lighting



Gigaspot, water fountains

SPOTLIGHT, FLAT LIGHT, FLASH LIGHT

ALWAYS STAY CONNECTED

Spotlight stainless steel



Flat Light stainless steel



Flash light stainless steel



A standard base that can be used for a variety of different lighting attachments – a shining example of a true all-rounder!

ILLUMINANTS
replaceable

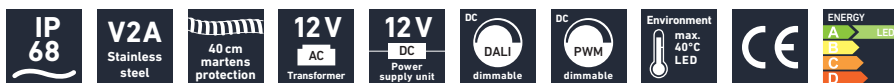

Standard version

Voltage	12 V AC/DC	
LED output	1.2 W	(Spotlight)
	2 W	(Flat Light/Flash Light)
LED colour	warm white	2700 K
Beam angle	90°	(Spotlight)
	100°	(Flat Light)
Light output	40 lm	(Spotlight)
	57 lm	(Flat Light/Flash Light)
Apparent power	2 W	(Spotlight)
	2.5 W	(Flat Light/Flash Light)
Dimmable	Yes	(Spotlight)
	No	(Flat Light/Flash Light)

Special design

Lighting accessories: Warm-light filter (Spotlight, Flat Light), Frosted glass (Spotlight) (optional)

Cable length and martens protection can be customised.

LED TECHNOLOGY, 12 V AC/DC		Stainless steel
Spotlight	1.2 W, warm white	20.472000
Flat Light	2 W, warm white	20.473000
Flash Light	2 W, warm white	20.474000

A data sheet with detailed lighting data for each product is available to download from our website. Subject to change without notice! Please observe the safety regulations and our terms and conditions!

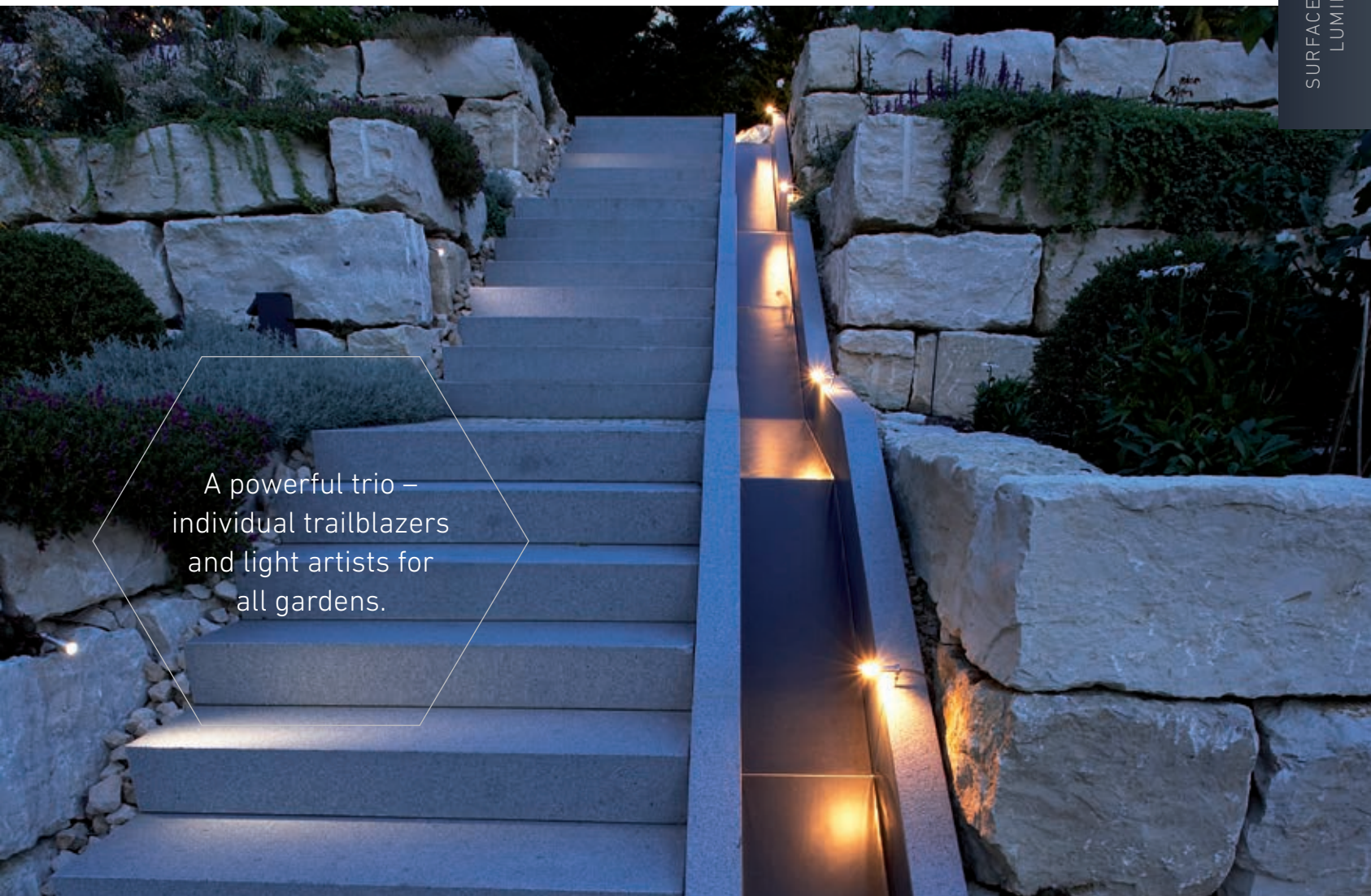

A powerful trio –
individual trailblazers
and light artists for
all gardens.

MOUNTING ACCESSORIES

(P. 98 – 121)

optionally available

Ground spike, luminaire holder
with retaining ring, base plate,
dowel



Luminaire holder and
retaining ring



Flat Light, fountain lighting

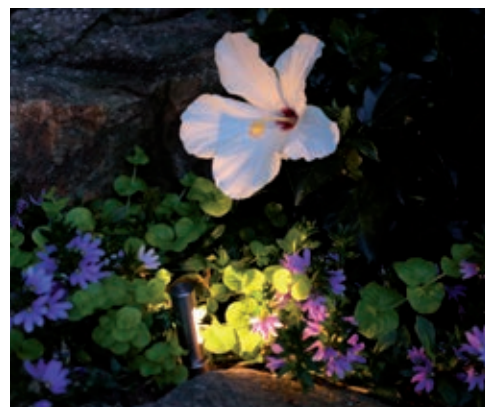

Flash Light, for fascinating light accents

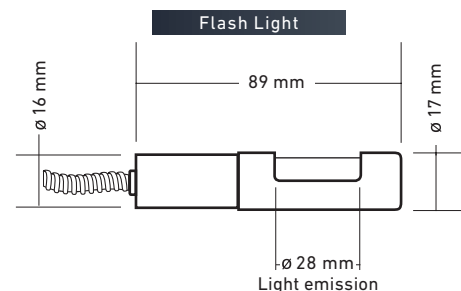
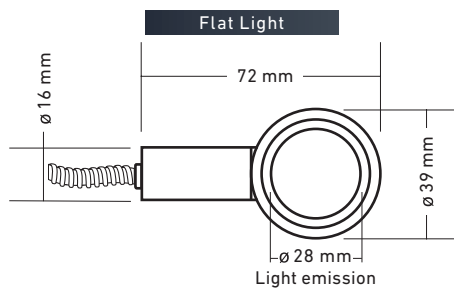
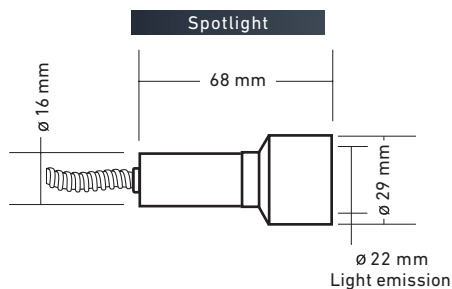

ULTRAFLEX

IT REALLY TURNS HEADS

A radiant beauty: slim, elegant, versatile and dressed in stylish black – perfect for evenings full of highlights!

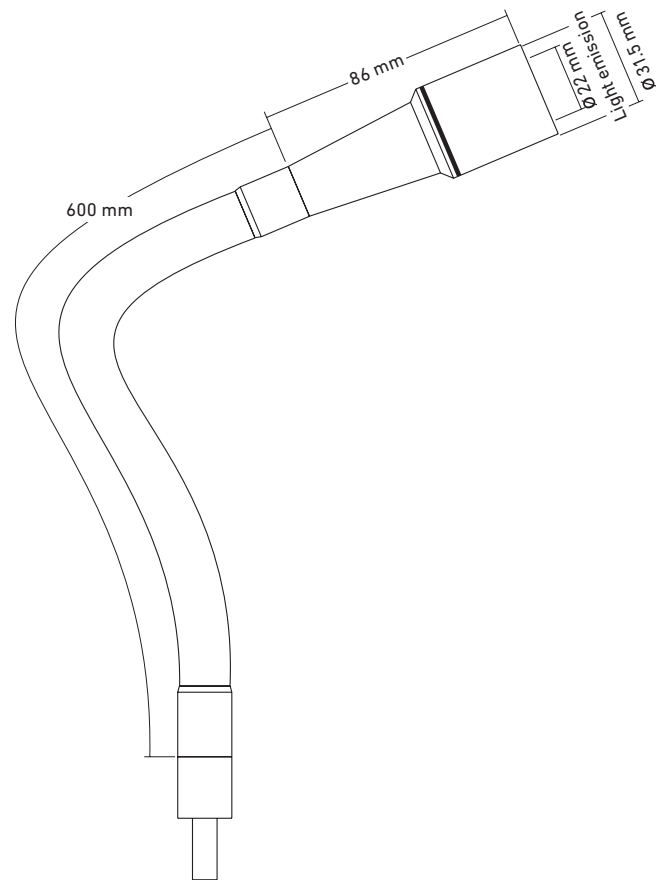

Standard version

Voltage	12 V AC/DC	
LED output	1 W	
LED colour	warm white	2700 K
Beam angle	10°, 20°, 30°, 44° x 12°	
Light output	58 lm	
Apparent power	2.5 W	
Installation option	Adapter with bolt for ground spike	

Special design

LED colour	warm white	3000 K
	cool white	6000 K
Lighting accessories (optional)	Warm-light filter, frosted glass, honeycomb anti-glare louvre, adapter with thread for base plate or dowel	
Cable length can be customised.		

ULTRAFLEX HP-LED, 12 V AC/DC	SDL-Black
1 W, 10°, warm white	20.800050
1 W, 20°, warm white	20.800051
1 W, 30°, warm white	20.800052
1 W, 44° x 12°, warm white	20.800053

A data sheet with detailed lighting data for each product is available to download from our website.
Subject to change without notice! Please observe the safety regulations and our terms and conditions!

Thanks to their
clever functionality,
all spotlights can
be positioned with
millimetre precision.



MOUNTING ACCESSORIES

(P. 98 – 121)

optionally available

Ground spike 280 mm
base plate M8, dowel,
tubular glare guard



As a result, the light can be directed precisely
where you want it!



Brilliant lighting effects guaranteed

MAXIFLEX

THE ONE WITH THE GOOSENECK

Versatile and simple installation options.
Hidden installation possible.

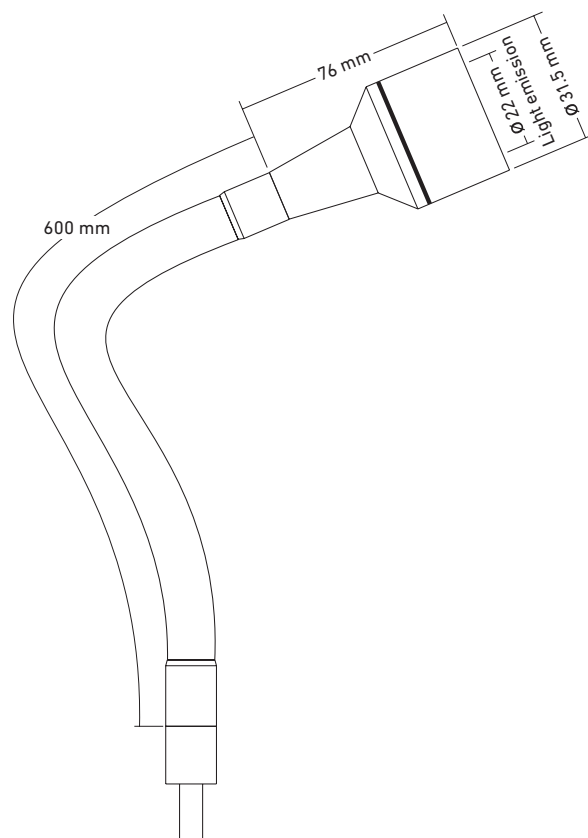

Standard version

Voltage	12 V AC/DC	(warm white)
Current	0.35 A	(RGBW)
LED output	3 W	(warm white)
	4 W	(RGBW)
LED colour	warm white	2700 K
	RGBW	4000 K
Beam angle	16°, 22°, 36°, 34° x 17°	
Light output	304 lm	(warm white)
Apparent power	5.5 W	(warm white)
	7 W	(RGBW)
Installation option	Adapter with bolt for ground spike	

Special design

LED colour	warm white	3000 K
	cool white	6500 K
Lighting accessories (optional)	Warm-light filter, frosted glass, honeycomb anti-glare louvre, diverse colour filters, adapter with thread for base plate or dowel	

Cable length can be customised.

MAXIFLEX HP-LED, 12 V AC/DC	SDL-Black
3 W, 16°, warm white	20.800060
3 W, 22°, warm white	20.800061
3 W, 36°, warm white	20.800062
3 W, 34° x 17°, warm white	20.800063
MAXIFLEX RGBW, 0.35 A	SDL-Black
4 W, 16°, RGBW	20.830060
4 W, 22°, RGBW	20.830061
4 W, 36°, RGBW	20.830062
4 W, 34° x 17°, RGBW	20.830063

A data sheet with detailed lighting data for each product is available to download from our website.
Subject to change without notice! Please observe the safety regulations and our terms and conditions!



High-quality workmanship guarantees durability and reliable performance.

MOUNTING ACCESSORIES

(P. 98 – 121)

optionally available

Ground spike 280 mm,
base plate M8, dowel,
tubular glare guard



Visible even in the twilight



Put details in the spotlight and add creative effects

MEGAFLEX

EXTREME FLEXIBILITY

Concealed installation possible – particularly flexible thanks to freely selectable luminaire orientation.

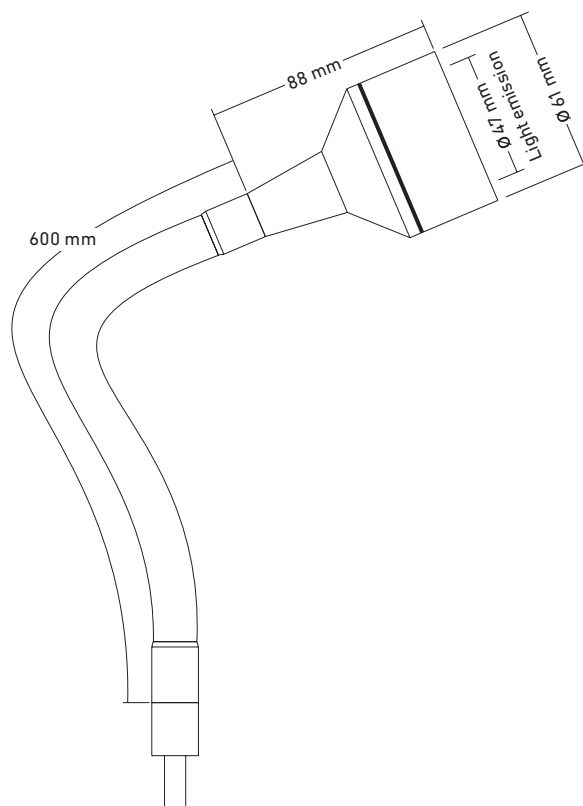

Standard version

Voltage	12 V AC/DC	(warm white)
Current	0.4 A	(RGBW)
LED output	9 W	(warm white)
	12 W	(RGBW)
LED colour	warm white	2700 K
	RGBW	4000 K
Beam angle	14°, 20°, 40°	
Light output	745 lm	(warm white)
Apparent power	11.5 W	(warm white)
	15 W	(RGBW)
Installation option	Adapter with bolt for ground spike	

Special design

LED colour	warm white	3000 K
	cool white	6200 K
Lighting accessories (optional)	Warm-light filter, frosted glass, honeycomb anti-glare louvre, adapter with thread for base plate or dowel	

Cable length can be customised.

MEGAFLEX HP-LED, 12 V AC/DC	SDL-Black
9 W, 14°, warm white	20.800070
9 W, 20°, warm white	20.800071
9 W, 40°, warm white	20.800072
MEGAFLEX RGBW, 0.4 A	SDL-Black
12 W, 14°, RGBW	20.800075
12 W, 20°, RGBW	20.800076
12 W, 40°, RGBW	20.800077

A data sheet with detailed lighting data for each product is available to download from our website.
Subject to change without notice! Please observe the safety regulations and our terms and conditions!

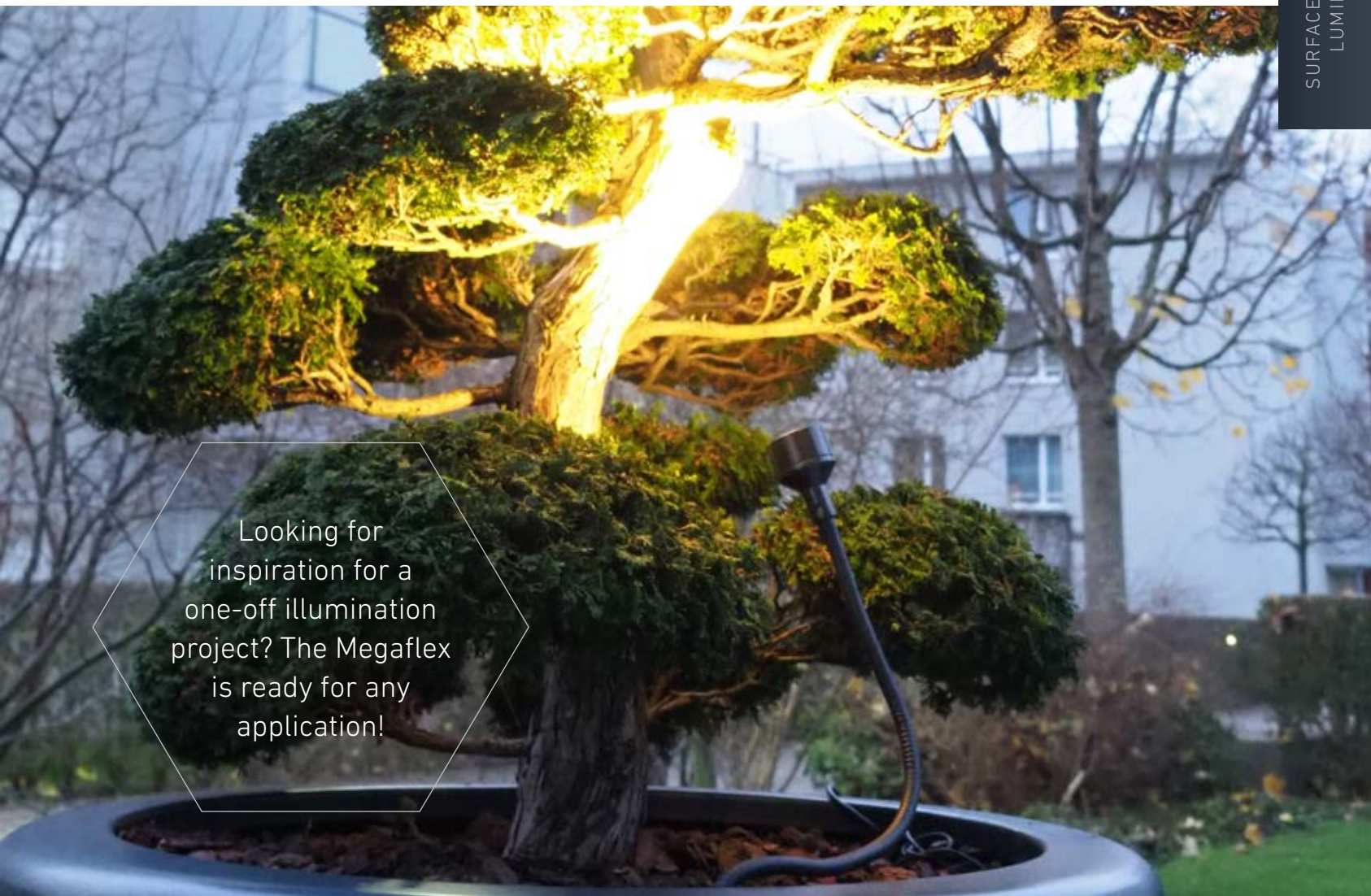

Looking for
inspiration for a
one-off illumination
project? The Megaflex
is ready for any
application!

MOUNTING ACCESSORIES

(P. 98 – 121)

optionally available

Ground spike 280 mm,
base plate M8, dowel,
tubular glare guard



Discreet mounting possible



Ideal for all types of planters



RECESSED LUMINAIRES

Angle Spot	P. 30–33	Superspot Effect	P. 46 / 47
Angle Spot Plus	P. 34 / 35	Superspot Compact	P. 50 / 51
Angle Spot Effect	P. 36 / 37	Superspot Compact Effect	P. 52 / 53
Microspot	P. 38 / 39	Cosmospot	P. 54 / 55
Superspot Mini	P. 40 / 41	Honeycomb Spot	P. 56 / 57
Superspot Mini Effect	P. 42 / 43	Honeycomb Spot Super	P. 58 / 59
Superspot	P. 44 / 45		

ANGLE SPOT

ALWAYS AT THE PERFECT ANGLE

One spotlight, many versions! Fantastic, varied effects can be achieved via clever division of the Angle Spot – this is lighting design in its purest form!

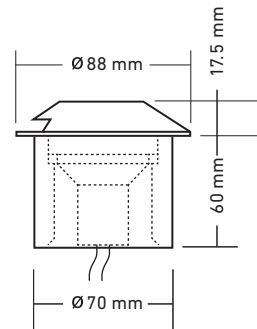

Standard HP-LED

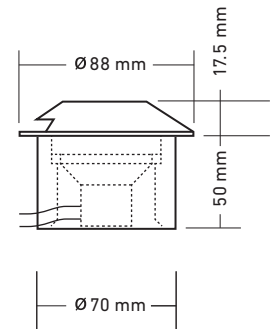

Short HP-LED

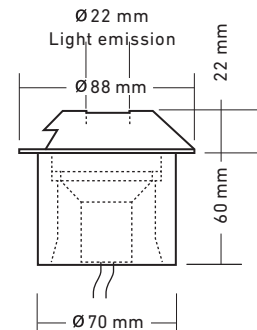

Plus HP-LED

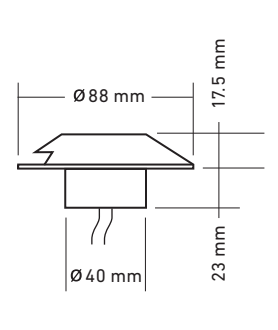

Effect-LED



LED MODULE
replaceable

Angle Spot 230° HP-LED
with aluminium heat sink



Temperature-controlled
HP-LED module –
replaceable!

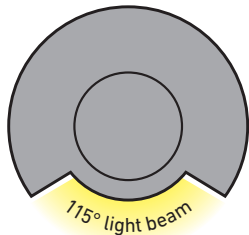

1-way

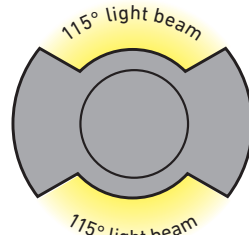

2-way

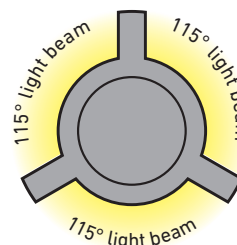

3-way

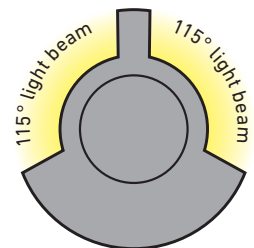

230°

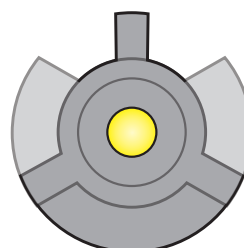

Plus additional
upwards light for
1-way, 2-way and
230° version

A data sheet with detailed lighting data for each product is available to download from our website.
Subject to change without notice! Please observe the safety regulations and our terms and conditions!



The Angle Spot –
for the perfect
interaction of nature,
water and light.

ANGLE SPOT

Standard version

Voltage	12 V AC/DC	
LED output	3 W	
LED colour	warm white	2700 K
Light emission	1-way, 2-way, 3-way, 230°	
Light output	163 lm per opening	
Apparent power	5.5 W	

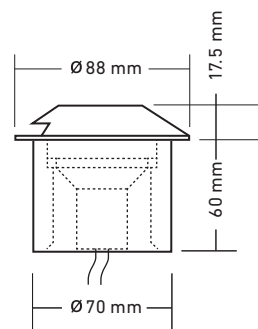

Standard HP-LED

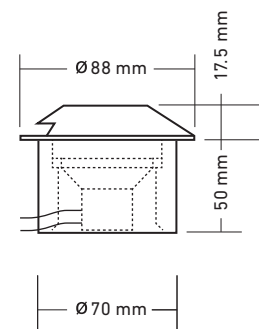

Short HP-LED

Special design

LED colour	warm white	3000 K
	cool white	6500 K

Low-profile design (short) with lateral cable outlet

Cable length can be customised.

Ø 72 – 80 mm

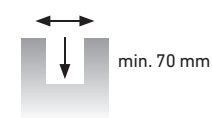

Angle Spot

Ø 72 – 80 mm

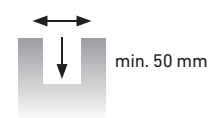

Angle Spot short

LED MODULE
replaceable



SDL-Black



Retro Bronze



1-way

2-way

3-way

230°



ANGLE SPOT HP-LED, 12 V AC/DC	Stainless steel	SDL-Black	Retro Bronze
1-way, 3 W, warm white, with aluminium heat sink	20.658052	20.800100	20.900100
2-way, 3 W, warm white, with aluminium heat sink	20.668052	20.800101	20.900101
3-way, 3 W, warm white, with aluminium heat sink	20.678052	20.800102	20.900102
230°, 3 W, warm white, with aluminium heat sink	20.688052	20.800103	20.900103

A data sheet with detailed lighting data for each product is available to download from our website.
Subject to change without notice! Please observe the safety regulations and our terms and conditions!

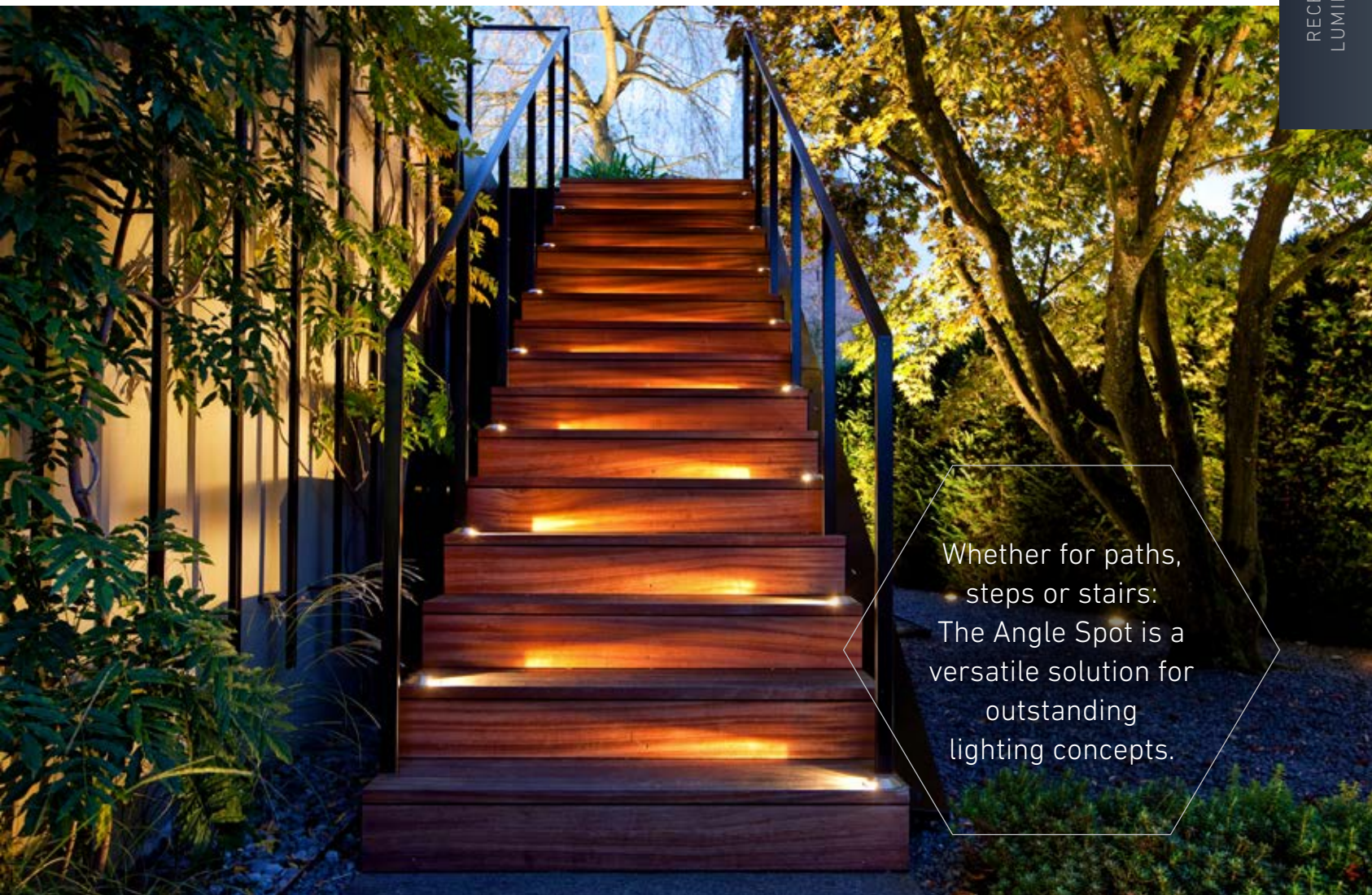

Whether for paths,
steps or stairs:
The Angle Spot is a
versatile solution for
outstanding
lighting concepts.

MOUNTING ACCESSORIES

(P. 98 – 121)

optionally available

Mounting tube, mounting box



Angle Spot, path lighting

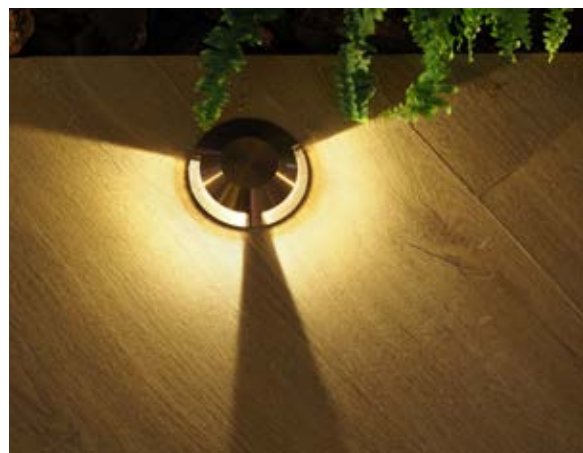

Angle Spot 230°, patio lighting

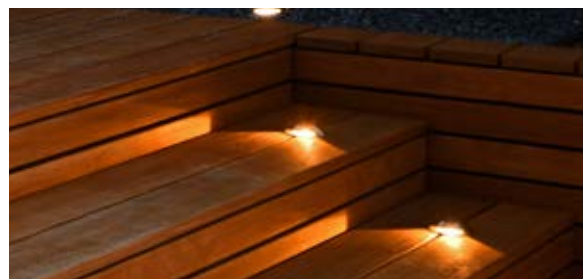

Angle Spot 1-way, step lighting

ANGLE SPOT PLUS

LET THERE BE (MORE) LIGHT!

The tall version of our versatile bestseller, the Angle Spot, in combination with the top light for even greater flexibility.

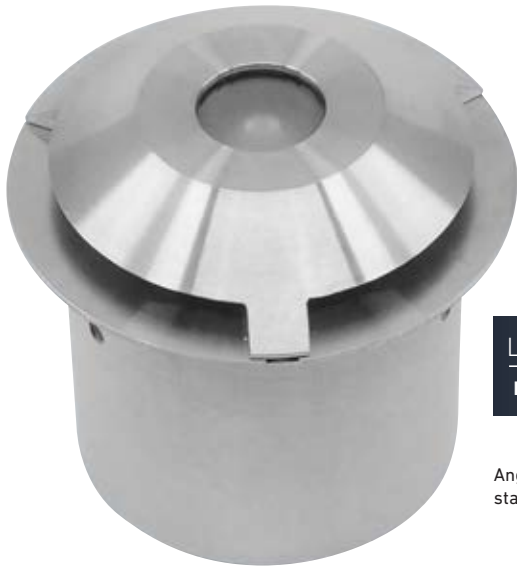
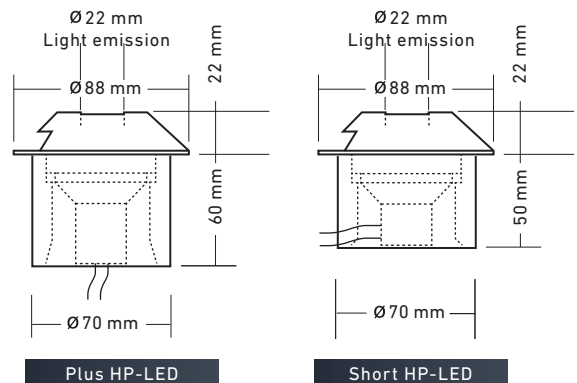

LED MODULE
replaceable

Angle Spot Plus 230°
stainless steel

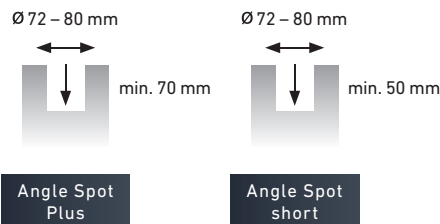

SDL-Black



Retro Bronze



Standard version

Voltage	12 V AC/DC
LED output	3 W
LED colour	warm white 2700 K
Light emission	1-way, 2-way, 230°
Light output	163 lm per opening
Apparent power	5.5 W

Special design

LED colour	warm white	3000 K
	cool white	6500 K
Low-profile design (short) with lateral cable outlet		
Cable length can be customised.		

ANGLE SPOT PLUS HP-LED, 12 V AC/DC	Stainless steel	SDL-Black	Retro Bronze
1-way, 3 W, warm white, with aluminium heat sink	20.658054	20.800110	20.900110
2-way, 3 W, warm white, with aluminium heat sink	20.668054	20.800111	20.900111
230°, 3 W, warm white, with aluminium heat sink	20.678054	20.800113	20.900113

A data sheet with detailed lighting data for each product is available to download from our website.
Subject to change without notice! Please observe the safety regulations and our terms and conditions!

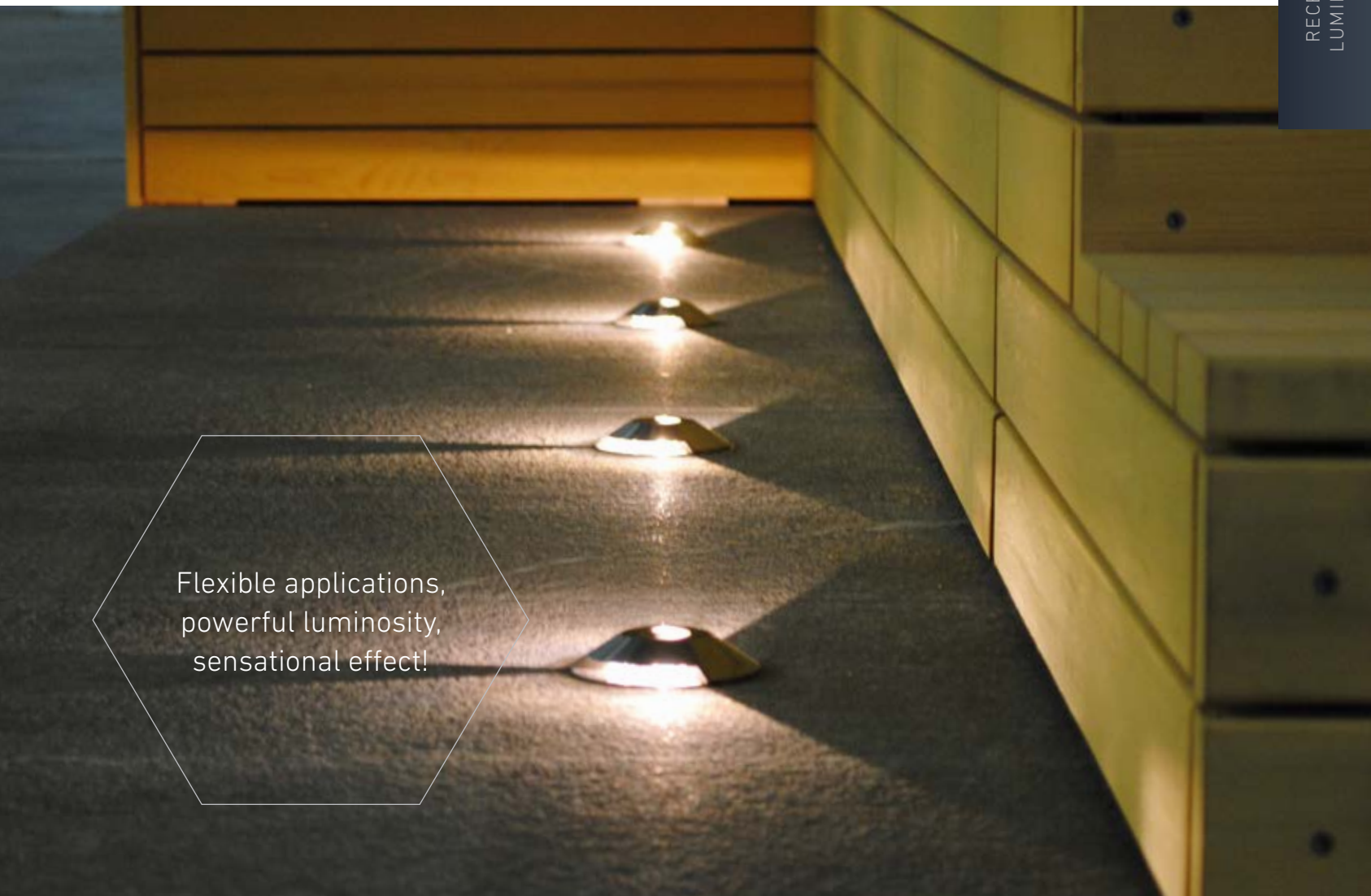

Flexible applications,
powerful luminosity,
sensational effect!

MOUNTING ACCESSORIES

(P. 98 – 121)

optionally available

Mounting tube,
mounting box

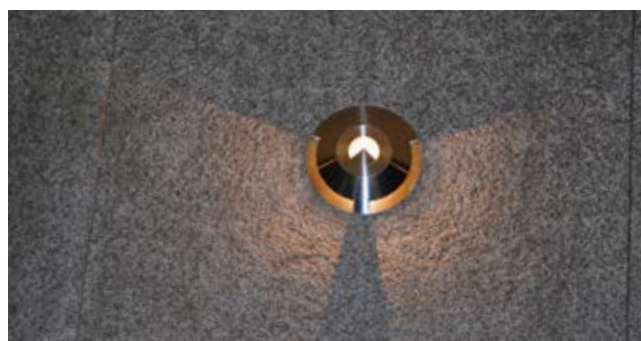

Angle Spot Plus 230°, wall lighting



Angle Spot Plus 230°, path lighting



Angle Spot Plus, elegant and timeless,
finished in high-quality V2A stainless
steel

ANGLE SPOT EFFECT

FOR THE FINEST LINES OF LIGHT

The Angle Spot Effect impresses with its low installation depth and fine light lines!

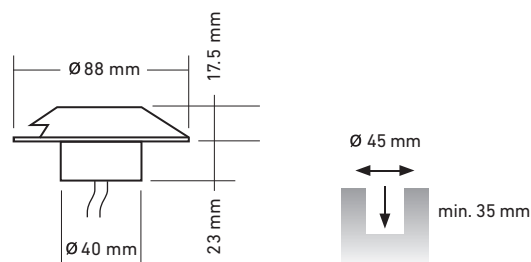

Standard version

Voltage	12 V AC/DC	
LED output	0.5 W	(1-way)
	1 W	(2-way, 230°)
	1.5 W	(3-way)
LED colour	warm white	
Light emission	1-way, 2-way, 3-way, 230°	
Light output	53 lm per opening	
Apparent power	1 W	(1-way)
	1.5 W	(2-way, 230°)
	2 W	(3-way)

Special design

LED colour	cool white blue
------------	--------------------

Cable length can be customised.

ANGLE SPOT EFFECT LED, 12 V AC/DC	Stainless steel	SDL-Black	Retro Bronze
1-way, 0.5 W, 5 LEDs, warm white	20.658053	20.802110	20.902110
2-way, 1 W, 10 LEDs, warm white	20.668053	20.802111	20.902111
3-way, 1.5 W, 15 LEDs, warm white	20.678053	20.802112	20.902112
230°, 1 W, 10 LEDs, warm white	20.688053	20.802113	20.902113

A data sheet with detailed lighting data for each product is available to download from our website.
Subject to change without notice! Please observe the safety regulations and our terms and conditions!

Well thought-out lighting concepts characterised by safety and beauty – rarely do these two aspects complement each other so perfectly!

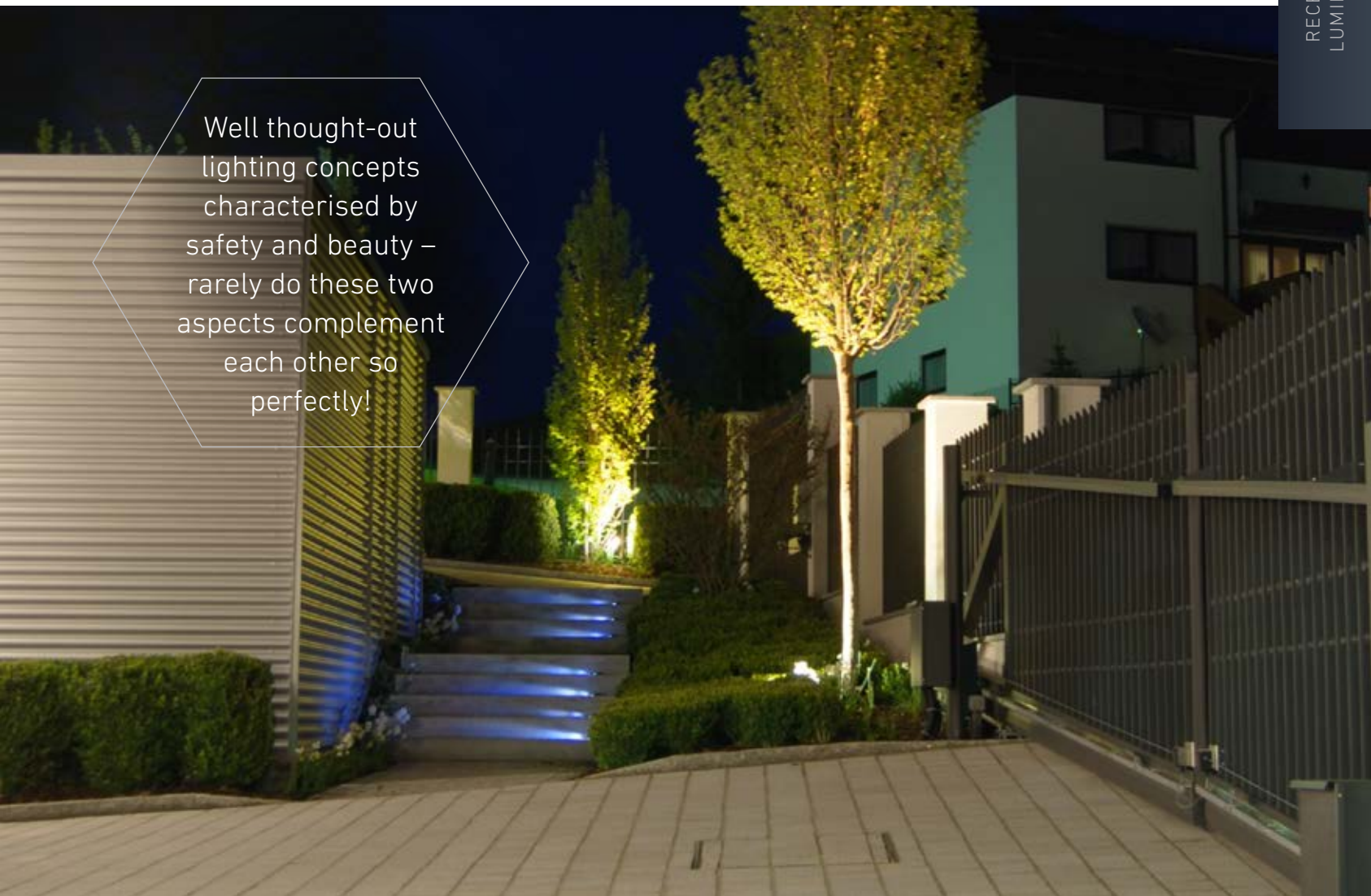

MOUNTING ACCESSORIES

(P. 98 – 121)

optionally available

Adhesives and sealants



Angle Spot Effect, 1-way
Step light

MICROSPOT

SUPER AND SUPER-SMALL

Barely two centimetres in diameter, yet it still packs a punch. The Microspot's super-small size means it can be used in very conspicuous areas – for maximum WOW-factor.

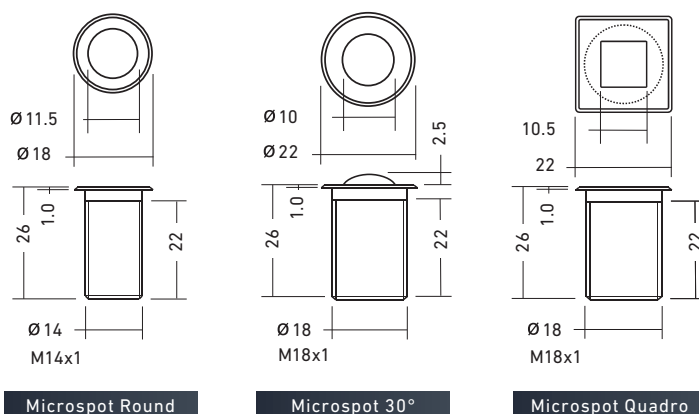

Microspot Round

Microspot 30°

Microspot Quadro

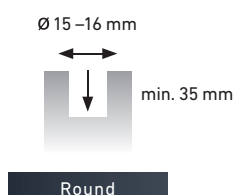

Round

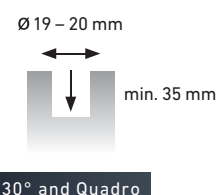

30° and Quadro

Standard version

Voltage	12 V DC
LED output	0.3 W (colours) 0.2 W (RGB)
LED colour	warm white, cool white, amber, red, green, blue, RGB
Light output	4 lm (warm white)
Apparent power	0.3 W
Cable length	can be customised.



MICROSPOT LED, 12 V DC	Round	30°	Quadro
0.3 W, warm white (3000 K)	20.489050	20.489070	20.489060
0.3 W, cool white (5000 K)	20.489051	20.489071	20.489061
0.3 W, amber	20.489052	20.489072	20.489062
0.3 W, red	20.489053	20.489073	20.489063
0.3 W, green	20.489054	20.489074	20.489064
0.3 W, blue	20.489055	20.489075	20.489065
0.2 W, RGB	20.489040	-	20.489041

A data sheet with detailed lighting data for each product is available to download from our website. Subject to change without notice! Please observe the safety regulations and our terms and conditions!



The Microspot:
Ideal spot lighting for
pools, walls, etc.

**MOUNTING
ACCESSORIES**
(P. 98 – 121)
optionally available

Adhesives and
sealants





Microspot, Jacuzzi lighting

Microspot, Jacuzzi lighting

SUPERSPOT MINI

COMPACT POWERHOUSE

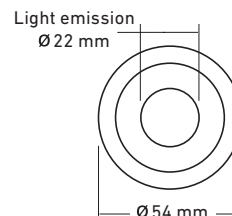
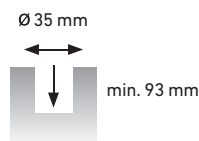
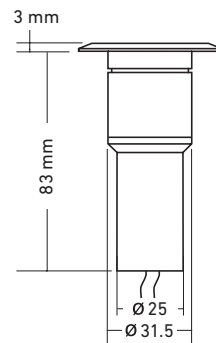
Maximum luminous intensity, minimum space requirements – the Superspot Mini truly shines in situations where every centimetre counts!



Standard version

Voltage	12 V AC/DC
LED output	1 W
LED colour	warm white 2700 K
Beam angle	10°, 20°, 30°, 44° x 12°
Light output	58 lm
Apparent power	2.5 W

Special design

LED colour	warm white	3000 K
	cool white	6000 K
Lighting accessories (optional)	Warm-light filter, frosted glass, honeycomb anti-glare louvre	
Cable length can be customised.		

SUPERSPOT MINI HP-LED, 12 V AC/DC	Stainless steel	SDL-Black	Retro Bronze
1 W, 10°, warm white	20.478070	20.800130	20.900130
1 W, 20°, warm white	20.478071	20.800131	20.900131
1 W, 30°, warm white	20.478073	20.800132	20.900132
1 W, 44° x 12°, warm white	20.478072	20.800133	20.900133

A data sheet with detailed lighting data for each product is available to download from our website. Subject to change without notice! Please observe the safety regulations and our terms and conditions!



The Superspot Mini –
ideal lighting for roof
gardens.

**MOUNTING
ACCESSORIES**
(P. 98 – 121)
optionally available

Assembly sleeve,
adhesives and
sealants



Patio lighting



Superspot Mini, step lighting

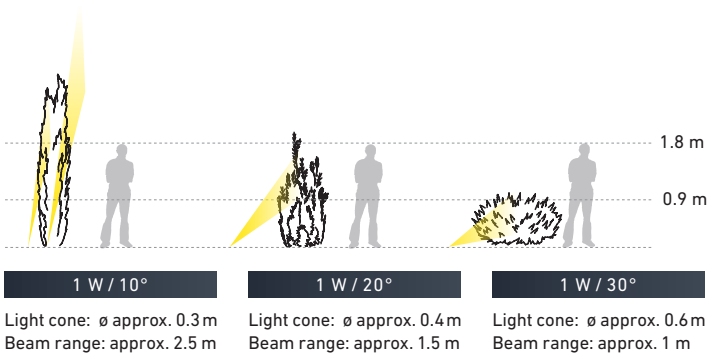

SUPERSPOT MINI EFFECT

LIGHT FOR EVERY MOOD

The Colour and Effect versions of the Superspot Mini – for eye-catching lighting with a pleasant warm-white tone. Inspires customers and planners alike!

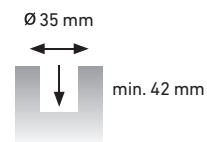
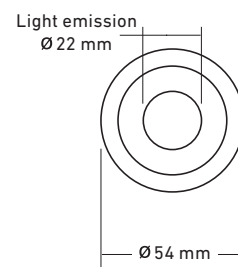
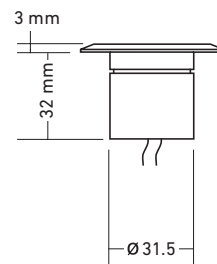

Standard version

Voltage	12 V AC/DC
LED output	0.8 W
LED colour	warm white
Light output	21 lm
Apparent power	1 W

Special design

LED colour	cool white blue
Lighting accessories (optional)	Warm-light filter, frosted glass
Cable length can be customised.	

SUPERSPOT MINI EFFECT-LED, 12 V AC/DC	Stainless steel	SDL-Black	Retro Bronze
0.8 W, 8 LEDs, warm white	20.478055	20.802160	20.902160

A data sheet with detailed lighting data for each product is available to download from our website. Subject to change without notice! Please observe the safety regulations and our General conditions!

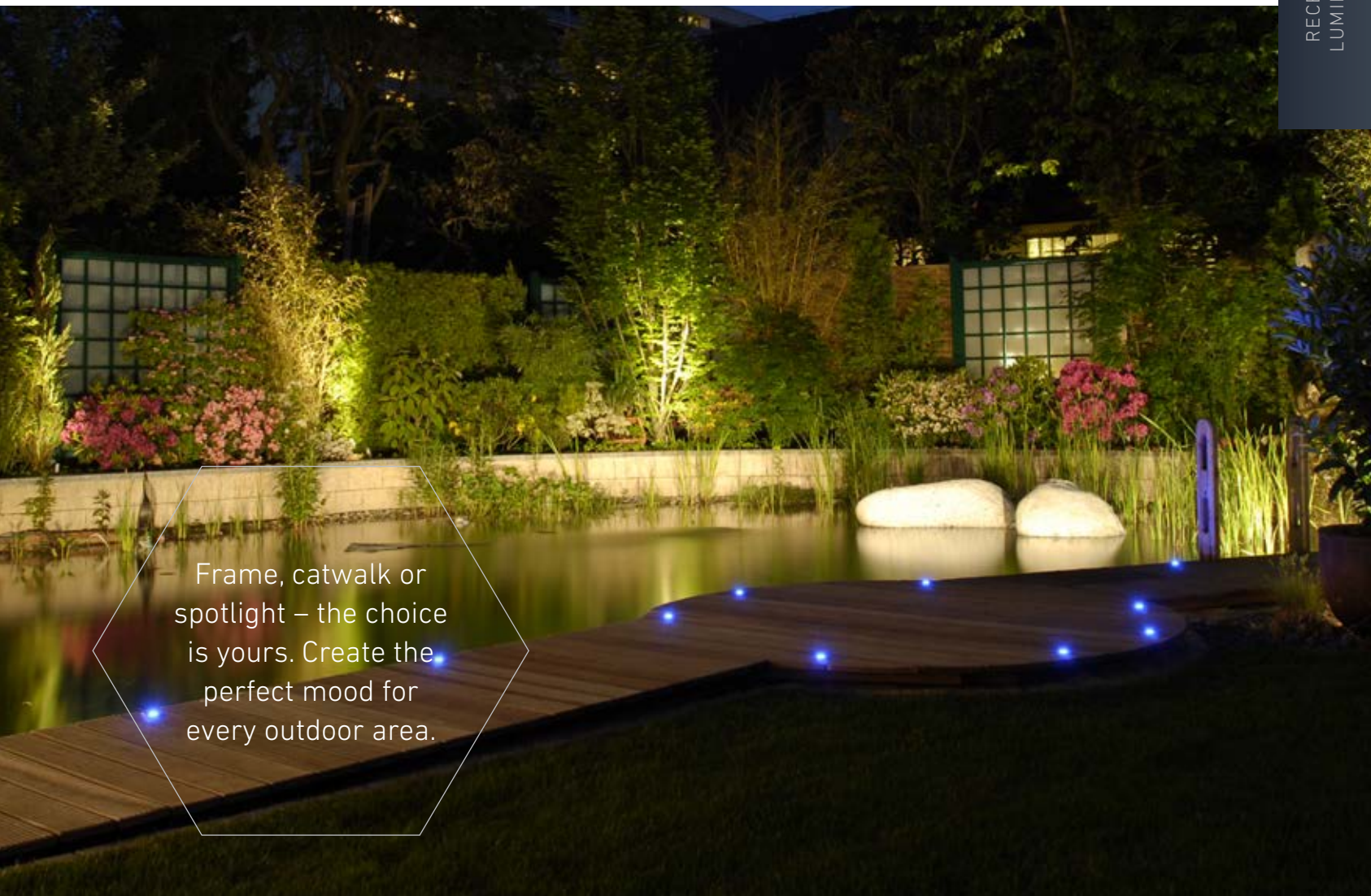

Frame, catwalk or
spotlight – the choice
is yours. Create the
perfect mood for
every outdoor area.

MOUNTING ACCESSORIES

(P. 98 – 121)

optionally available

Assembly sleeve,
adhesives and
sealants



Superspot Mini Effect, blue

SUPERSPOT

LET'S HEAR SOME APPLAUSE FOR THIS LITTLE STAR

Not just any old spot – a Superspot!
Available in different versions depending on your requirements.



Superspot HP-LED stainless steel

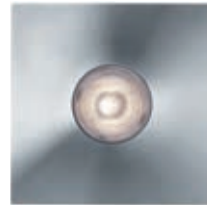

Upper housing: square

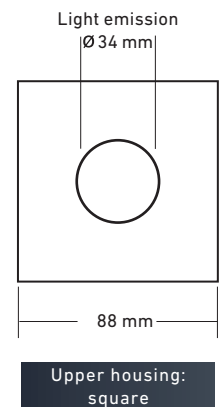
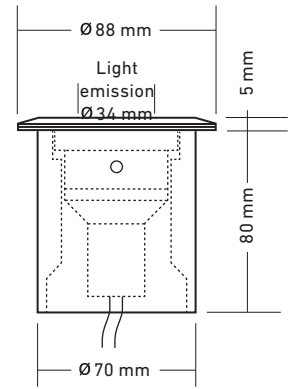
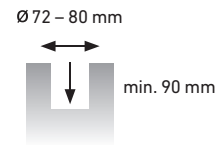

Upper housing: square

LED MODULE
replaceable



Standard version

Voltage	12 V AC/DC	(warm white)
Current	0.35 A	(RGBW)
LED output	3 W,	(warm white)
	4 W	(RGBW)
LED colour	warm white	2700 K
	RGBW	4000 K
Beam angle	16°, 22°, 36°, 34° x 17°	
Light output	304 lm	(warm white)
Apparent power	5.5 W	(warm white)
	7 W	(RGBW)

Special design

LED colour	warm white	3000 K
	cool white	6500 K
Lighting accessories (optional)	Warm-light filter, frosted glass, honeycomb anti-glare louvre, diverse colour filters, upper housing: square	
Cable length can be customised.		



SDL-Black

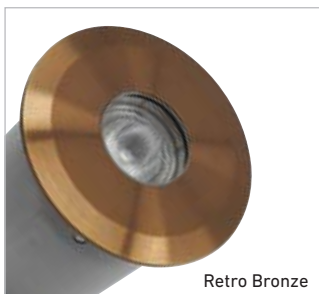

Retro Bronze

SUPERSPOT HP-LED, 12 V AC/DC	Stainless steel	SDL-Black	Retro Bronze
3 W, 16°, warm white, with aluminium heat sink	20.459053	20.800120	20.900120
3 W, 22°, warm white, with aluminium heat sink	20.459050	20.800121	20.900121
3 W, 36°, warm white, with aluminium heat sink	20.459054	20.800122	20.900122
3 W, 34° x 17°, warm white, with aluminium heat sink	20.459055	20.800123	20.900123
SUPERSPOT RGBW, 0.35 A	Stainless steel	SDL-Black	Retro Bronze
4 W, 16°, RGBW, with aluminium heat sink	20.430120	20.830120	20.930120
4 W, 22°, RGBW, with aluminium heat sink	20.430121	20.830121	20.930121
4 W, 36°, RGBW, with aluminium heat sink	20.430122	20.830122	20.930122
4 W, 34° x 17°, RGBW, with aluminium heat sink	20.430123	20.830123	20.930123

A data sheet with detailed lighting data for each product is available to download from our website.

Subject to change without notice! Please observe the safety regulations and our terms and conditions!

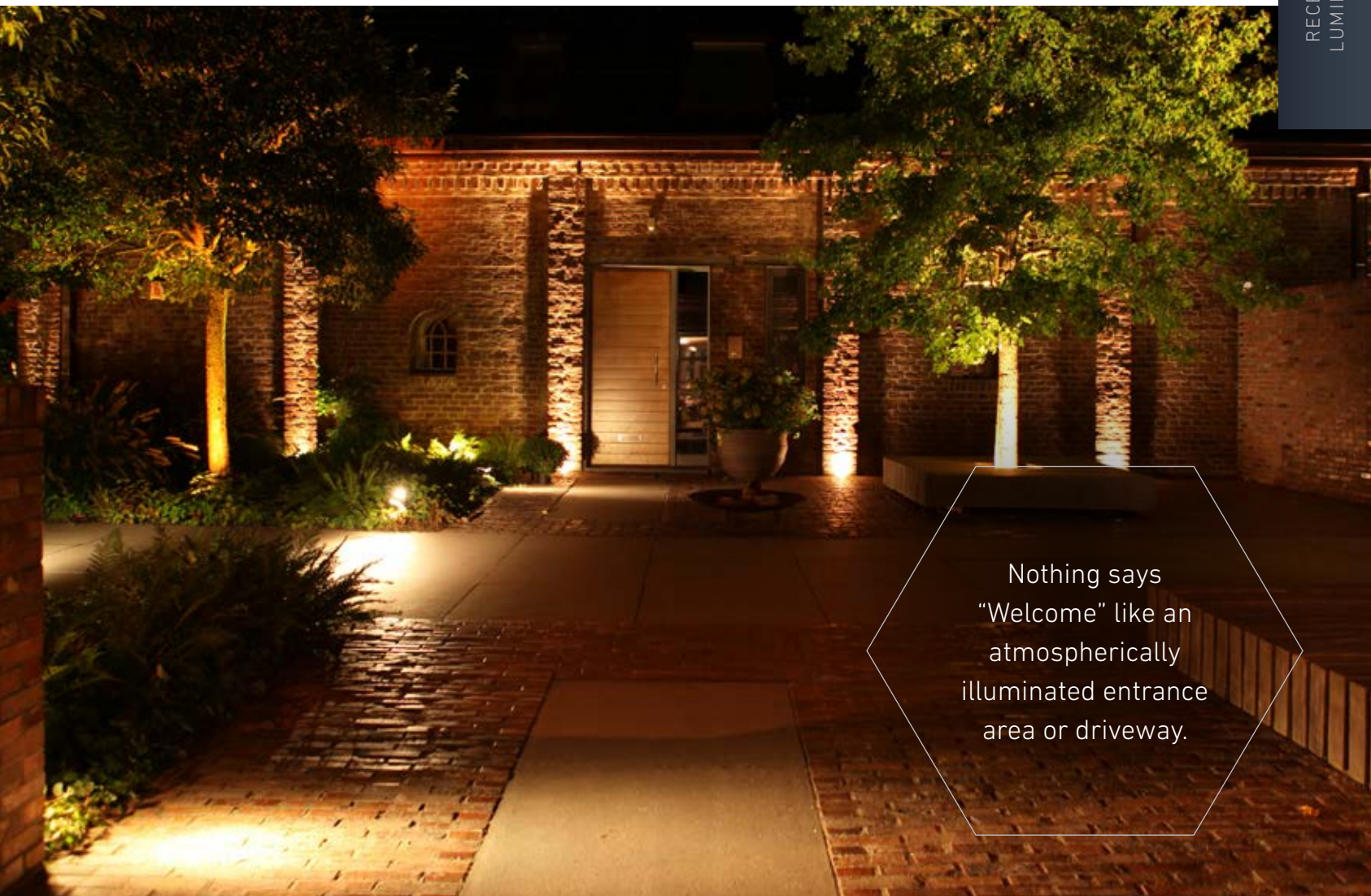

Nothing says
"Welcome" like an
atmospherically
illuminated entrance
area or driveway.

**MOUNTING
ACCESSORIES**
(P. 98 – 121)
optionally available

Mounting tube,
mounting box



Superspot, path lighting

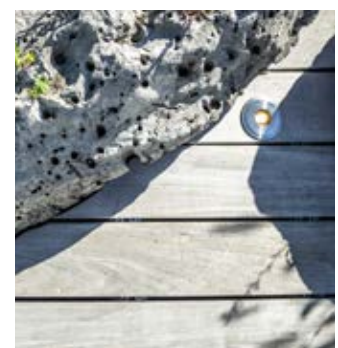

Superspot round

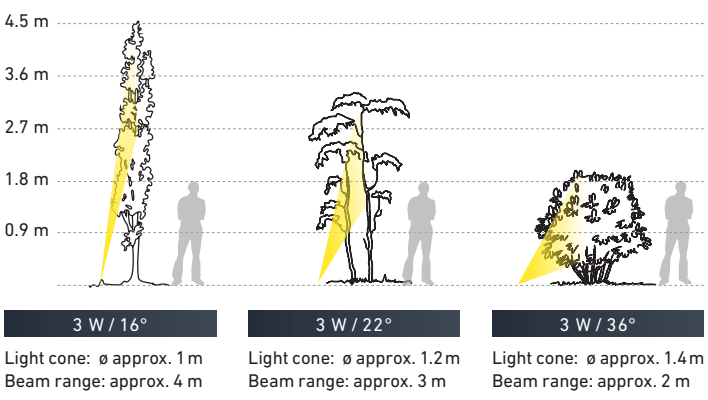

Superspot, for magical moments in the most beautiful gardens

SUPERSPOT EFFECT

A BRILLIANT EFFECT

If you are looking for a spotlight to create fabulous lighting effects, look no further than the Superspot Effect! Particularly versatile thanks to its low installation depth.



Superspot Effect
stainless steel

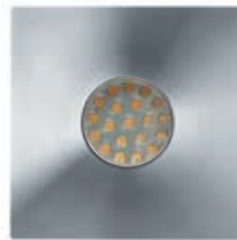
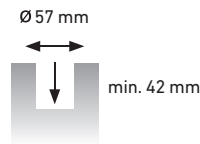

Upper housing:
square

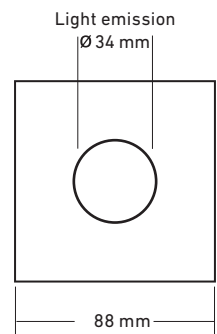
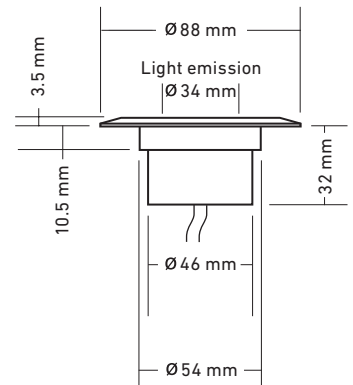

Upper housing:
square



SDL-Black



Retro Bronze

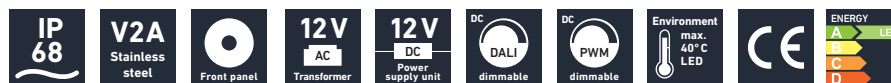

Standard version

Voltage	12 V AC/DC
LED output	2 W
LED colour	warm white
Light output	54 lm
Apparent power	2.5 W

Special design

LED colour	cool white blue
Lighting accessories (optional)	Warm-light filter, frosted glass, upper housing: square
Cable length can be customised.	

SUPERSPOT EFFECT-LED, 12 V AC/DC	Stainless steel	SDL-Black	Retro Bronze
2 W, 20 LEDs, warm white	20.458052	20.802150	20.902150

A data sheet with detailed lighting data for each product is available to download from our website.
Subject to change without notice! Please observe the safety regulations and our terms and conditions!

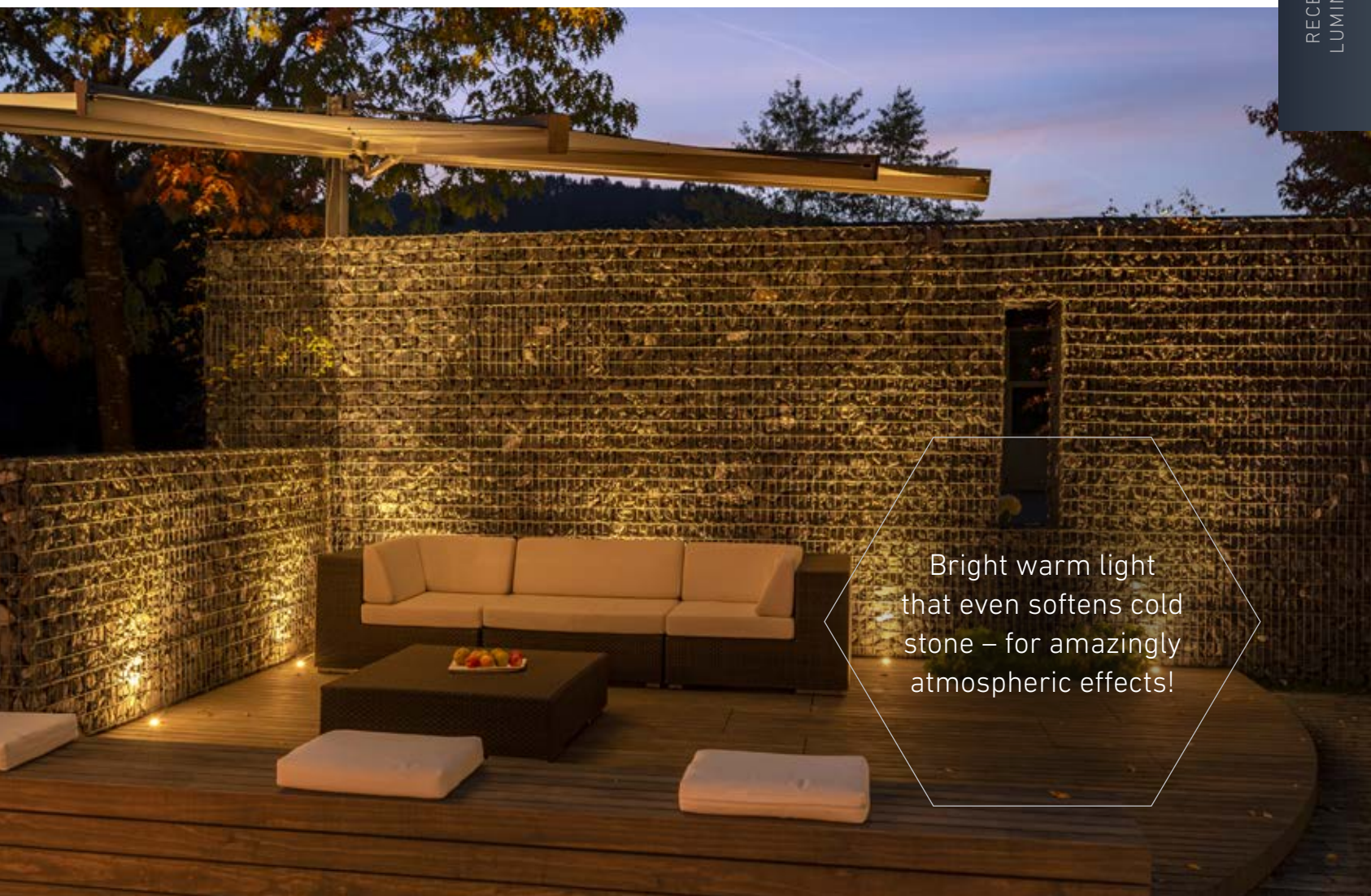

Bright warm light
that even softens cold
stone – for amazingly
atmospheric effects!

MOUNTING ACCESSORIES

(P. 98 – 121)

optionally available

Aluminium heat sink,
adhesives and sealants

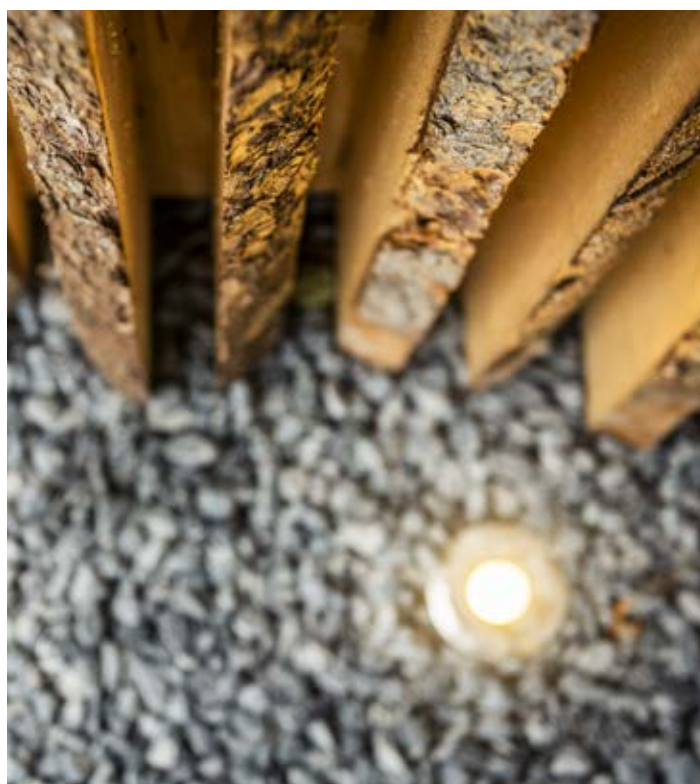

Superspot Effect, warm-white light for special effects



STRONG PIECES, MADE BY STAUB DESIGNLIGHT.

Designed for decades of trouble-free operation.
Made to last virtually forever.

Solid stainless steel – turned from a single, solid piece – configured and finished by experienced specialists at the staub designlight ag manufactory ... these are the “solid foundations” on which we create premium luminaires that will do their job perfectly for decades to come. Durable technology, perfected down to the last detail for maximum reliability – through our approach to quality, staub designlight

also provides proof of sustainability, which is becoming increasingly important to end customers. Incidentally, we are also constantly improving our products when it comes to ensuring careful use of resources. For example, the state-of-the-art LED technology inside our luminaires, which is now found throughout our range, contributes to significant energy savings.





**IN-HOUSE
PRODUCTION**

Swiss
quality product



7
YEARS
WARRANTY

on all
staub designlight
luminaires



**IP 68-
TESTED**

100 % waterproof

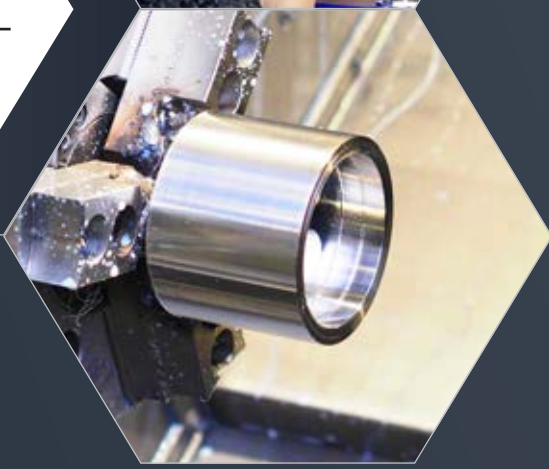

SUPERSPOT COMPACT

SUPER-COMPACT LUMINOSITY

Ideal for pergolas – particularly compact and bright.

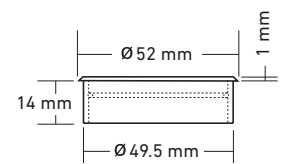
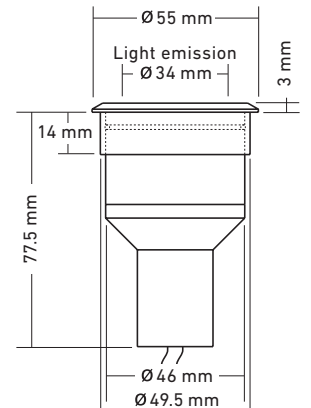
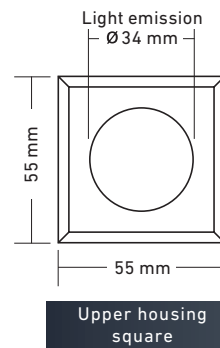

Assembly sleeve

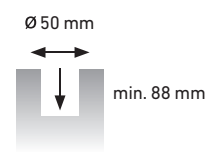

LED MODULE
replaceable



Standard version

Voltage	12 V AC/DC	(warm white)
Current	0.35 A	(RGBW)
LED output	3 W,	(warm white)
	4 W	(RGBW)
LED colour	warm white	2700 K
	RGBW	4000 K
Beam angle	16°, 22°, 36°, 34° x 17°	
Light output	304 lm	(warm white)
Apparent power	5.5 W	(warm white)
	7 W	(RGBW)

Special design

LED colour	warm white	3000 K
	cool white	6500 K
Lighting accessories (optional)	Warm-light filter, frosted glass, honeycomb anti-glare louvre, diverse colour filters, upper housing: square	
Cable length can be customised.		

SUPERSPOT COMPACT HP-LED, 12 V AC/DC	Stainless steel	SDL-Black	Retro Bronze
3 W, 16°, warm white	20.459153	20.800125	20.900125
3 W, 22°, warm white	20.459150	20.800126	20.900126
3 W, 36°, warm white	20.459154	20.800127	20.900127
3 W, 34° x 17°, warm white	20.459155	20.800128	20.900128
SUPERSPOT COMPACT RGBW, 0.35 A	Stainless steel	SDL-Black	Retro Bronze
4 W, 16°, RGBW	20.430125	20.830125	20.930125
4 W, 22°, RGBW	20.430126	20.830126	20.930126
4 W, 36°, RGBW	20.430127	20.830127	20.930127
4 W, 34° x 17°, RGBW	20.430128	20.830128	20.930128



A data sheet with detailed lighting data for each product is available to download from our website.
Subject to change without notice! Please observe the safety regulations and our terms and conditions!

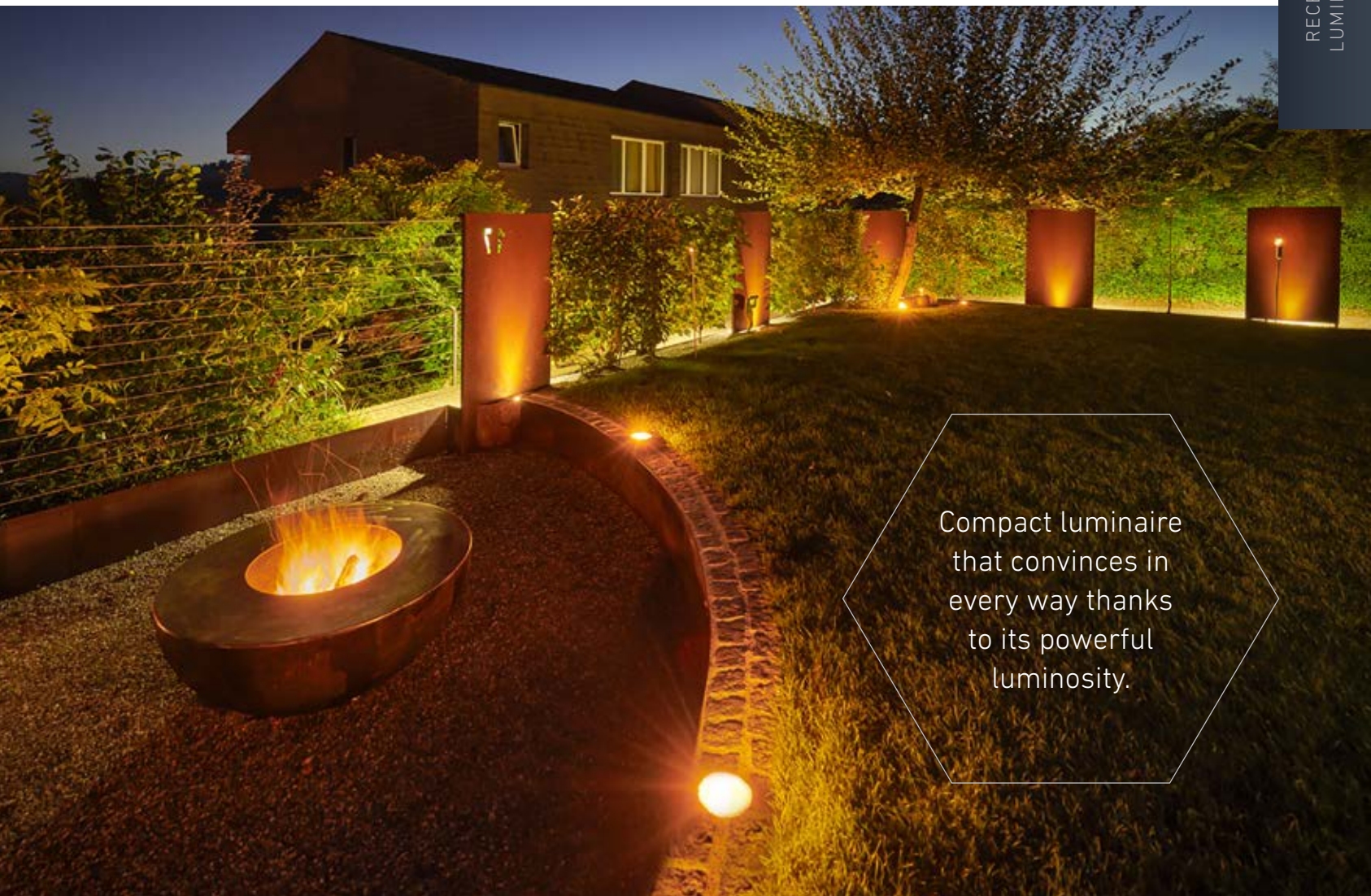

Compact luminaire that convinces in every way thanks to its powerful luminosity.

MOUNTING ACCESSORIES
(P. 98 – 121)
optionally available

Assembly sleeve, adhesives and sealants



Superspot Compact, roof-terrace lighting

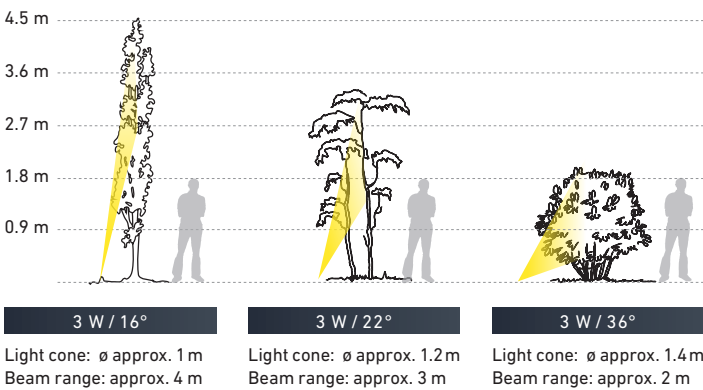

Superspot Compact, upper housing: square



Superspot Compact, indirect illumination

SUPERSPOT COMPACT EFFECT

THE SPECIAL EFFECTS IN A COMPACT DESIGN

All the advantages of the Superspot Compact with the extra effects – for especially beautiful moments in the garden!



Superspot Compact Effect
stainless steel

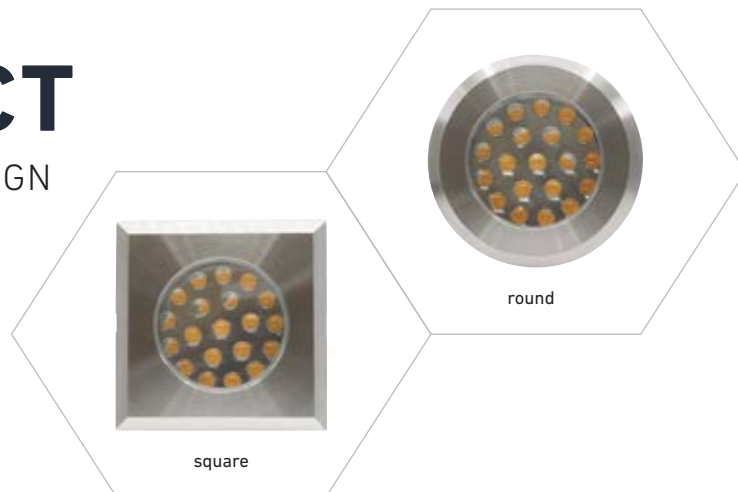

square

round

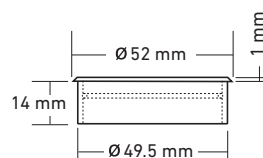
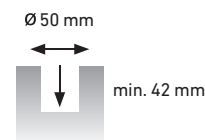
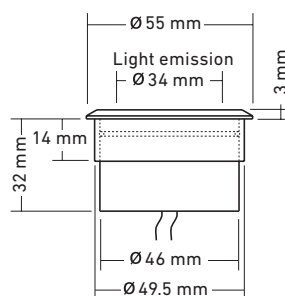

Assembly sleeve

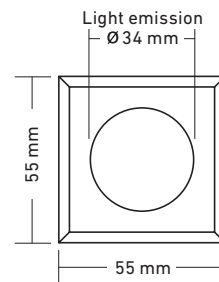

Upper housing
square



SDL-Black



Retro Bronze

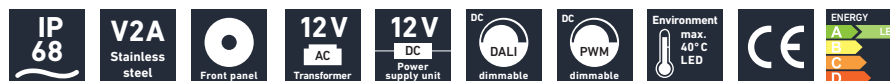

Standard version

Voltage	12 V AC/DC
LED output	2 W
LED colour	warm white
Light output	54 lm
Apparent power	2.5 W

Special design

LED colour	cool white blue
Lighting accessories (optional)	Warm-light filter, frosted glass, upper housing: square
Cable length can be customised.	

SUPERSPOT EFFECT-LED, 12 V AC/DC	Stainless steel	SDL-Black	Retro Bronze
2 W, 20 LEDs, warm white	20.458152	20.802170	20.902170

A data sheet with detailed lighting data for each product is available to download from our website.
Subject to change without notice! Please observe the safety regulations and our terms and conditions!

Superspot
Compact Effect:
Because light speaks
its own atmospheric
language!



MOUNTING ACCESSORIES

(P. 98 – 121)

optionally available

Assembly sleeve,
adhesive and sealant

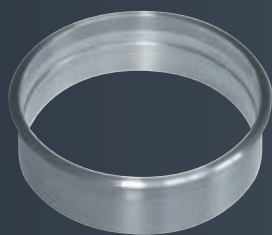

Superspot Compact Effect, upper housing: square



Superspot Compact Effect, roof-terrace lighting

COSMOSPOT

DESIGN MEETS PERFORMANCE

The Cosmospot combines the design of the Superspot with the light output of the Honeycomb Spot. The perfect luminaire for applications in which pivoting of the light cone is not required.

Cosmospot stainless steel



LED MODULE
replaceable

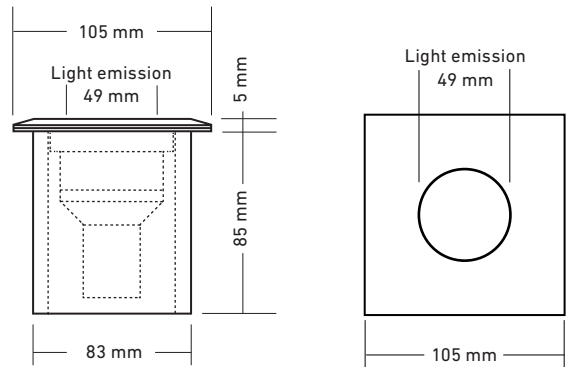

Upper housing:
square

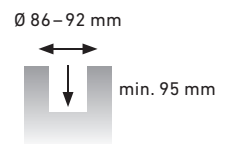

Standard version

Voltage	12 V AC/DC	(warm white)
Current	0.4 A	(RGBW)
LED output	9 W	(warm white)
	12 W	(RGBW)
LED colour	warm white	2700 K
	RGBW	4000 K
Beam angle	14°, 20°, 40°	
Light output	745 lm	(warm white)
Apparent power	11.5 W	(warm white)
	15 W	(RGBW)

Special design

LED colour	warm white	3000 K
	cool white	6200 K
Lighting accessories (optional)	Warm-light filter, frosted glass, honeycomb anti-glare louvre, upper housing: square	
Cable length can be customised.		



COSMOSPOT HP-LED, 12 V AC/DC	Stainless steel	SDL-Black	Retro Bronze
9 W, 14°, warm white, with aluminium heat sink	20.698130	20.898130	20.998130
9 W, 20°, warm white, with aluminium heat sink	20.698131	20.898131	20.998131
9 W, 40°, warm white, with aluminium heat sink	20.698132	20.898132	20.998132
COSMOSPOT RGBW, 0.4 A	Stainless steel	SDL-Black	Retro Bronze
12 W, 14°, RGBW, with aluminium heat sink	20.698135	20.898135	20.998135
12 W, 20°, RGBW, with aluminium heat sink	20.698136	20.898136	20.998136
12 W, 40°, RGBW, with aluminium heat sink	20.698137	20.898137	20.998137

A data sheet with detailed lighting data for each product is available to download from our website.
Subject to change without notice! Please observe the safety regulations and our terms and conditions!

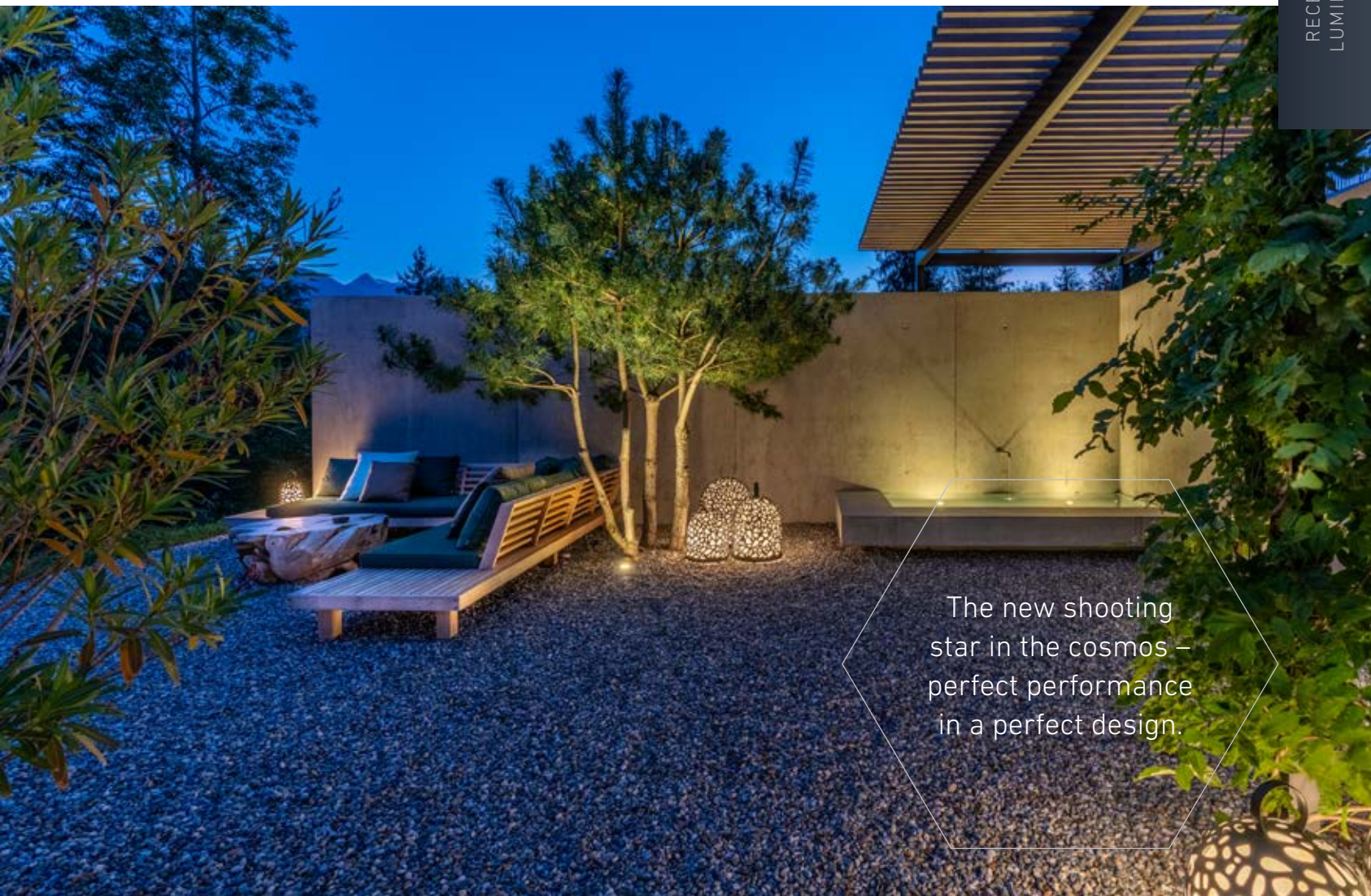

The new shooting star in the cosmos – perfect performance in a perfect design.

MOUNTING ACCESSORIES
(P. 98 – 121)
optionally available

Mounting tube



Cosmospot, outdoor shower

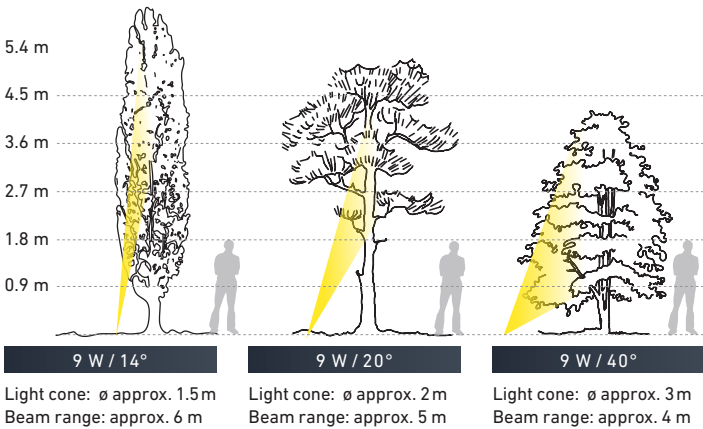

Cosmospot, driveway

HONEYCOMB SPOT

SQUARING THE CIRCLE

Technology that delights – and light that inspires.
The Honeycomb Spot is available in both round and square versions!



Honeycomb Spot stainless steel

LED MODULE
replaceable

Rotatable to 360°
40° inclination

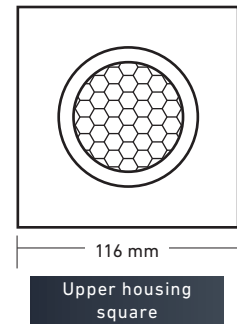
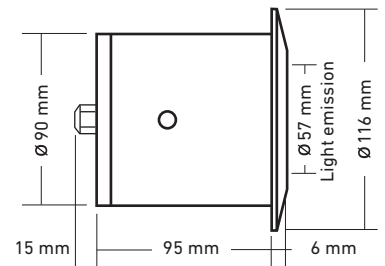
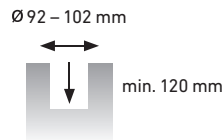

Upper housing square



Standard version

Voltage	12 V AC/DC	(warm white)
Current	0.4 A	(RGBW)
LED output	9 W	(warm white)
	12 W	(RGBW)
LED colour	warm white	2700 K
	RGBW	4000 K
Beam angle	14°, 20°, 40°	
Light output	570 lm with honeycomb anti-glare louvre	(warm white)
	745 lm without honeycomb anti-glare louvre	(warm white)
Apparent power	11.5 W	(warm white)
	15 W	(RGBW)

Special design

LED colour	warm white	3000 K
	cool white	6200 K
Lighting accessories (optional)	Warm-light filter, frosted glass, upper housing: square	
Cable length can be customised.		



SDL-Black



Retro Bronze

HONEYCOMB SPOT HP-LED, 12 V AC/DC	Stainless steel	SDL-Black	Retro Bronze
9 W, 14°, warm white	20.698102	20.800150	20.900150
9 W, 20°, warm white	20.698103	20.800151	20.900151
9 W, 40°, warm white	20.698101	20.800152	20.900152
HONEYCOMB SPOT RGBW, 0.4 A	Stainless steel	SDL-Black	Retro Bronze
12 W, 14°, RGBW	20.698118	20.800153	20.900153
12 W, 20°, RGBW	20.698119	20.800154	20.900154
12 W, 40°, RGBW	20.698120	20.800155	20.900155

A data sheet with detailed lighting data for each product is available to download from our website.
Subject to change without notice! Please observe the safety regulations and our terms and conditions!

Spaces, stairs, shrubs
– no matter what you
want to accentuate,
the Honeycomb Spot
is up to the task!



MOUNTING ACCESSORIES

(P. 98 – 121)

optionally available

Mounting tube, mounting box



Mounting tube



Upper housing: square



Honeycomb Spot, wall lighting



Honeycomb Spot, warm white, swivels continuously up to 40°, can be rotated 360°

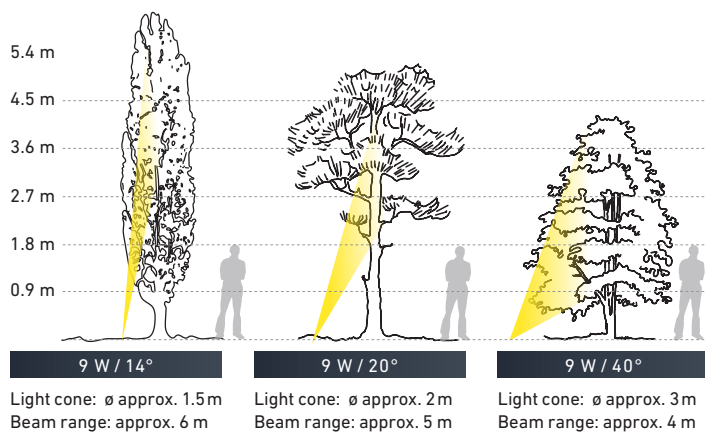

HONEYCOMB SPOT SUPER

TAKE A TURN IN THE SPOTLIGHT

This module can be swivelled to ensure optimal alignment and give you maximum creative freedom.



Honeycomb Spot Super stainless steel

LED UNIT
replaceable

Rotatable to 360°
40° inclination

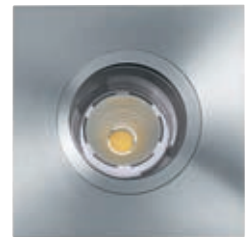
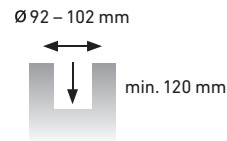

Honeycomb Spot Super

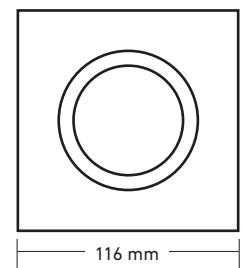
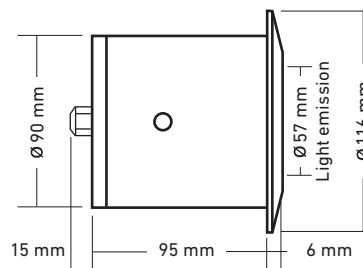

Upper housing square



SDL-Black

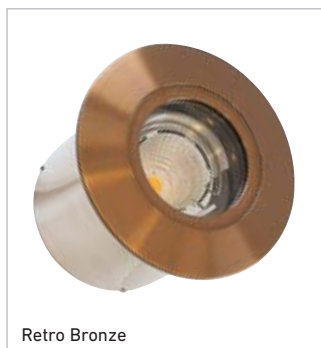

Retro Bronze

Standard version

Voltage	12 V DC
LED output	10 W
LED colour	warm white 2700 K
Beam angle	20°, 30°, 40°, 80°
Light output	1028 lm
Apparent power	15 W

Special design

Lighting accessories (optional)	Warm-light filter, frosted glass, honeycomb anti-glare louvre, upper housing: square
---------------------------------	--

Cable length can be customised.

HONEYCOMB SPOT SUPER HP-LED, 12 V AC/DC	Stainless steel	SDL-Black	Retro Bronze
10 W, 20°, warm white	20.698109	20.800170	20.900170
10 W, 30°, warm white	20.698110	20.800171	20.900171
10 W, 40°, warm white	20.698111	20.800172	20.900172
10 W, 80°, warm white	20.698112	20.800173	20.900173

A data sheet with detailed lighting data for each product is available to download from our website. Subject to change without notice! Please observe the safety regulations and our terms and conditions!

The Honeycomb Spot Super – puts garden objects in the perfect light.



MOUNTING ACCESSORIES

(P. 98 – 121)

optionally available

Mounting tube, mounting box



Mounting tube



Honeycomb Spot Super, patio lighting



Honeycomb Spot Super, tree lighting

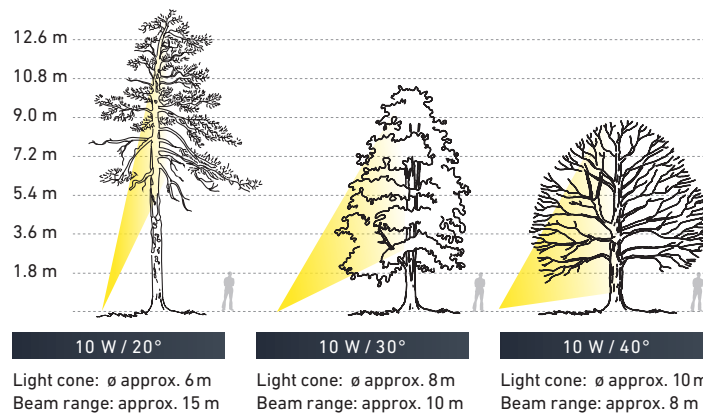





PATH LIGHTING

Down Light

P 62 / 63

Tube Light

P. 64 / 65

Topspot

P. 72 / 73

Stilys

P. 74 / 75

DOWN LIGHT

THE LONG AND SHORT OF IT

For glare-free lighting that is particularly effective in walls, staircases and walls.

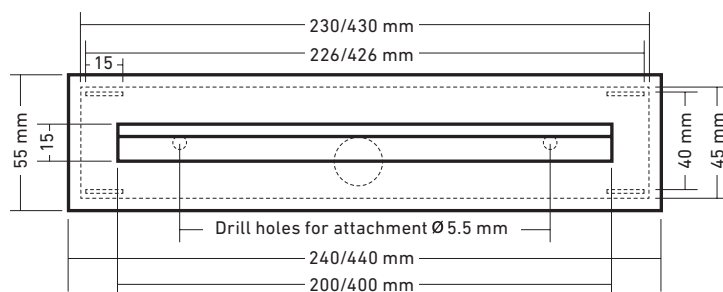

Down Light, front view



Down Light
stainless steel

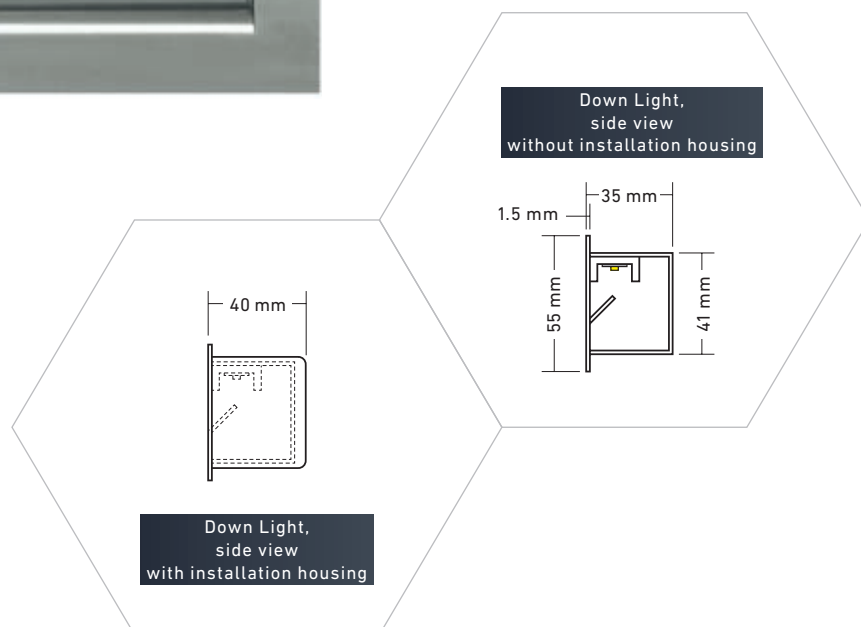

Standard version

Voltage	12 V DC	
LED output	4 W	(200 mm)
	8 W	(400 mm)
LED colour	warm white	2700 K
Light emission	200 x 15 mm 400 x 15 mm	
Light output	154 lm	(200 mm)
	308 lm	(400 mm)
Apparent power	4 W	(200 mm)
	8 W	(400 mm)

Special version

Other housing lengths as per customer requirements.

Cable length can be customised.

DOWN LIGHT LED, 12 V DC	Stainless steel
200, 4 W, warm white	20.150710
400, 8 W, warm white	20.150730
SA, special version (made to order)	20.150740
Installation housing 200	20.150800
Installation housing 400	20.150801

A data sheet with detailed lighting data for each product is available to download from our website.
Subject to change without notice! Please observe the safety regulations and our terms and conditions!

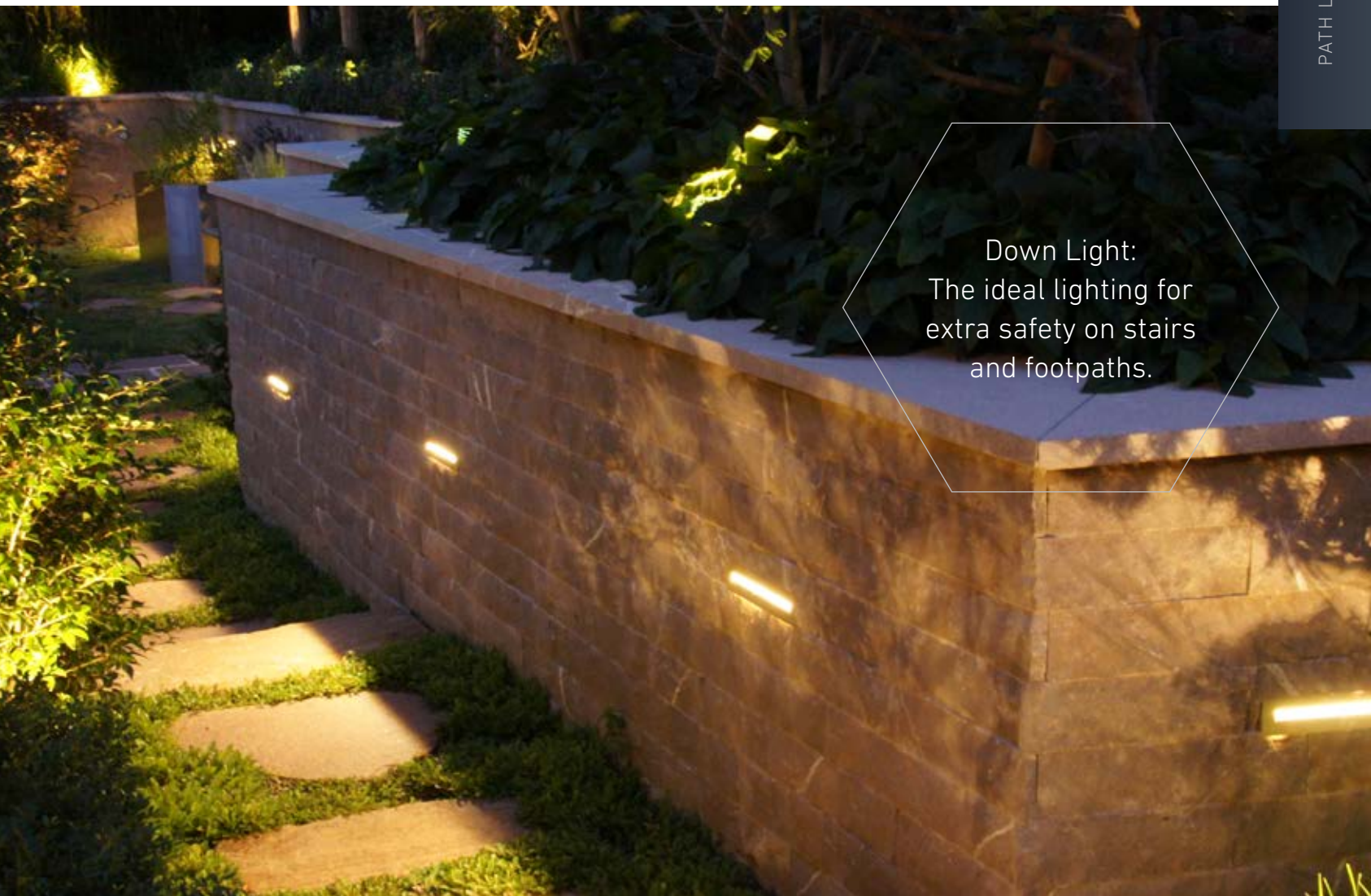

Down Light:
The ideal lighting for
extra safety on stairs
and footpaths.

**MOUNTING
ACCESSORIES**
(P. 98 – 121)
optionally available
Installation housing,
adhesive and sealant

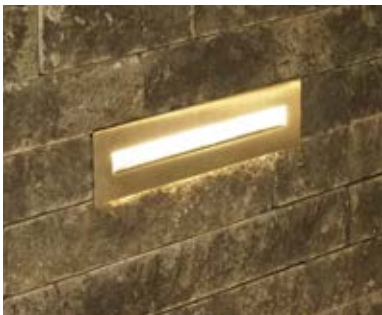

Down Light, path lighting



Down Light, stair lighting

TUBE LIGHT

FOR PERFECT PRIVACY AND EXQUISITE MOMENTS

Optimal lighting doesn't always have to catch the eye! Tube Light is the solution for absolutely glare-free lighting with powerful highlights.



Tube Light 430/40
180° version,
stainless steel

Tube Light 430/60
180° version,
stainless steel

Tube Light 430
1-way version,
stainless steel

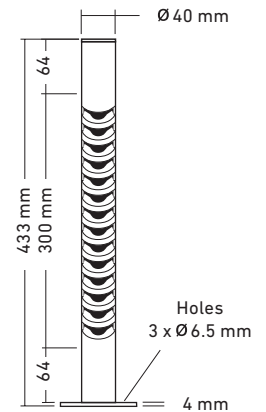

Tube Light 430/40
180°

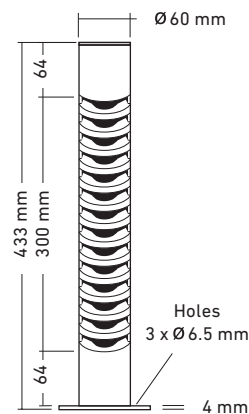

Tube Light 430/60
180°

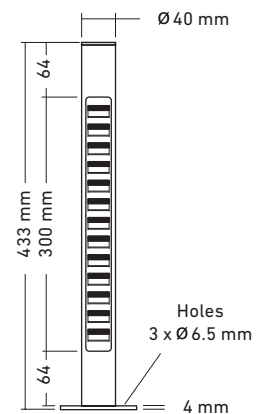

Tube Light 430
1-way



Standard version

Voltage	12 V DC
LED output	8 W
LED colour	warm white 2700 K
Tube size	Height 430 mm, Ø 40 mm Height 430 mm, Ø 60 mm
Version	1-way and 180°
Light output	308 lm
Apparent power	8 W

Special version

Other tube lengths as per customer requirements.

Cable length can be customised.

TUBE LIGHT LED, 12 V DC	Stainless steel
430/40 1-way, 8 W, warm white	20.150550
430/60 1-way, 8 W, warm white	20.150590
430/40 180°, 8 W, warm white	20.150570
430/60 180°, 8 W, warm white	20.150580
SA, special version (made to order)	20.150560

A data sheet with detailed lighting data for each product is available to download from our website.
Subject to change without notice! Please observe the safety regulations and our terms and conditions!



Standing ovations
for our Tube Lights
– perfect light meets
perfect design.

MOUNTING ACCESSORIES

(P. 98 – 121)

optionally available

Ground anchor



Tube Light 430/40, 180°

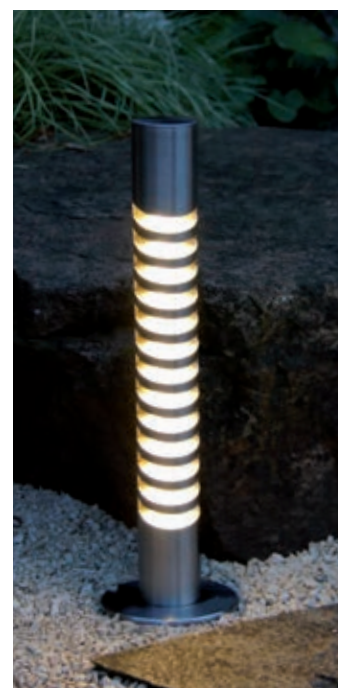

Tube Light 430/60, 180°



**STAUB DESIGNLIGHT
AROUSES EMOTIONS.
A FEAST FOR THE SENSES.**







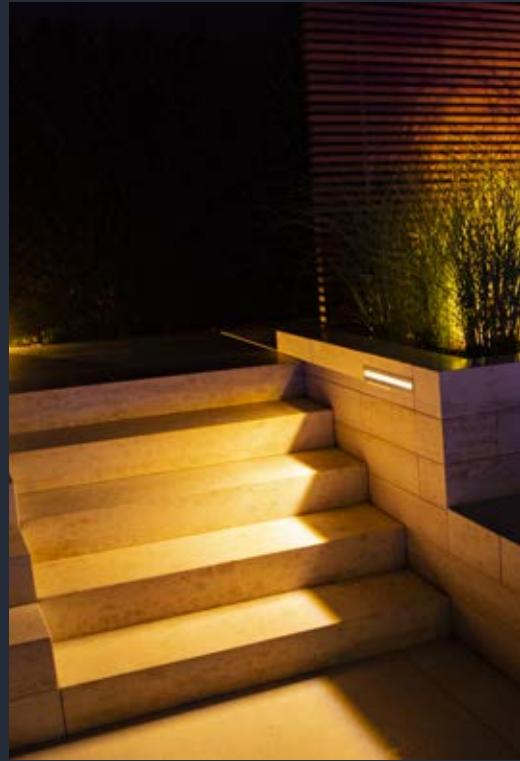



TOPSPOT

IT'S ON THE RIGHT PATH

Creates an avenue of light – ideal for truly spectacular highlights. The path and immediate surroundings are accentuated and merged harmoniously together.



Topspot SA with
Ultraspot and Megaspot,
stainless steel

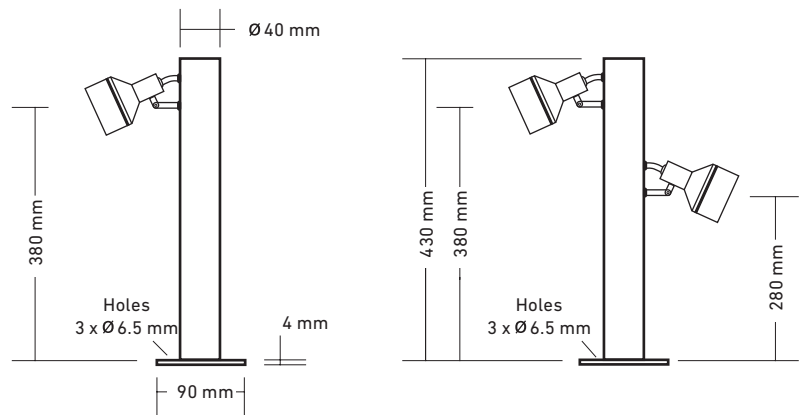

Topspot 430, 1-way

Topspot 430, 2-way

Standard version

Voltage	12 V AC/DC	
LED output	3 W	(1-way with Maxispot)
	2 x 3 W	(2-way with Maxispot)
	9 W	(1-way with Megaspot)
	2 x 9 W	(2-way with Megaspot)
LED colour	warm white	2700 K
Beam angle	36°	(Maxispot)
	40°	(Megaspot)
Tube size	Height 430 mm, Ø 40 mm	
Light output	see individual luminaires	
Apparent power	5.5 W	(1-way with Maxispot)
	11 W	(2-way with Maxispot)
	11.5 W	(1-way with Megaspot)
	23 W	(2-way with Megaspot)

Special version

LED colour	warm white	3000 K
	cool white	6200 K

Lighting accessories
(optional) Warm-light filter, frosted glass,
honeycomb anti-glare louvre

Luminaire configuration and tube length can be customised.

Cable length can be customised.



TOPSPOT 430 HP-LED, 12 V AC/DC	Stainless steel	SDL-Black	Retro Bronze
1-way, 1x Maxispot 3 W, 36°, warm white	20.150450	20.850450	20.950450
2-way, 2x Maxispot 3 W, 36°, warm white	20.150451	20.850451	20.950451
1-way, 1x Megaspot 9 W, 40°, warm white	20.150463	20.850463	20.950463
2-way, 2x Megaspot 9 W, 40°, warm white	20.150460	20.850460	20.950460
SA, special version (made to order)	20.150452	–	–

A data sheet with detailed lighting data for each product is available to download from our website.
Subject to change without notice! Please observe the safety regulations and our terms and conditions!



The Topspot makes you an artist – create unique lighting masterpieces!

MOUNTING ACCESSORIES
(P. 98 – 121)
optionally available

Ground anchor



Topspot 2-way, for perfect spotlighting



Topspot 2-way, stair lighting

STILYS

SLENDER AND BEAUTIFUL

Clear design language, minimalist, elegant, timeless.
This luminaire never fails to delight thanks to its elegant design.
Its powerful luminance also makes it ideal for any footpath.

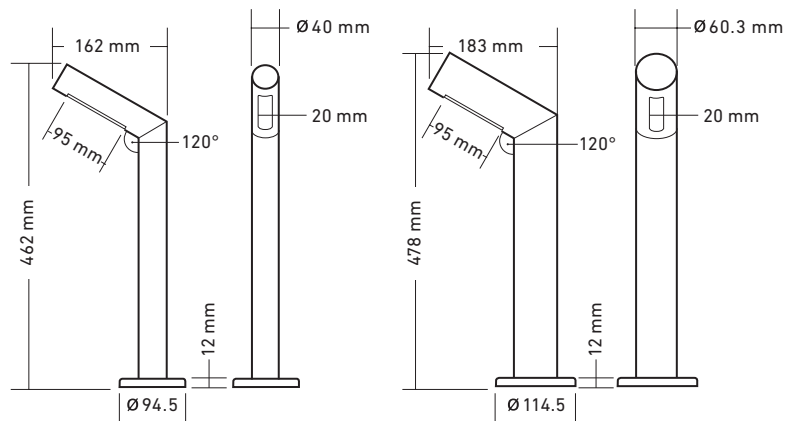

Stilys RS

Stilys RM



Stilys RS
stainless steel

Stilys RM
stainless steel

Stilys ES
stainless steel

Stilys EM
stainless steel

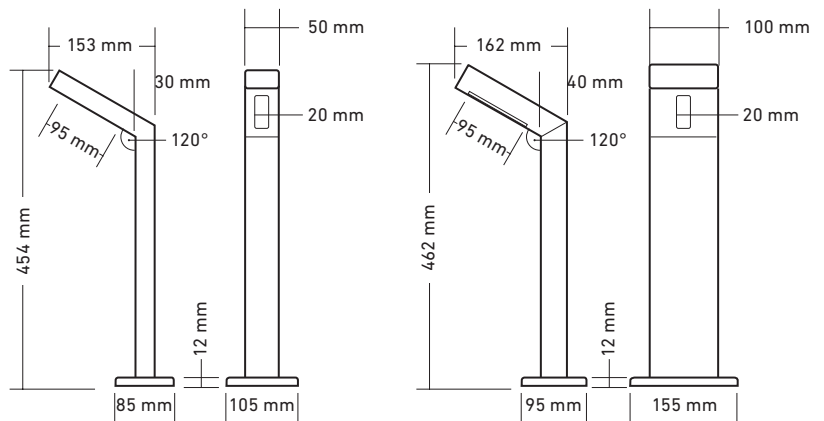

Stilys ES

Stilys EM



Standard version

Voltage	12 V DC
LED output	4.5 W
LED colour	warm white 2700 K
Beam angle	approx. 60°
Light output	320 lm
Apparent power	5 W

Special version

Cable length can be customised.
Custom tube sizes are possible.

STILYS LED	Stainless steel
RS, 4.5 W, warm white	20.150900
RM, 4.5 W, warm white	20.150901
ES, 4.5 W, warm white	20.150910
EM, 4.5 W, warm white	20.150911

A data sheet with detailed lighting data for each product is available to download from our website.
Subject to change without notice! Please observe the safety regulations and our terms and conditions!

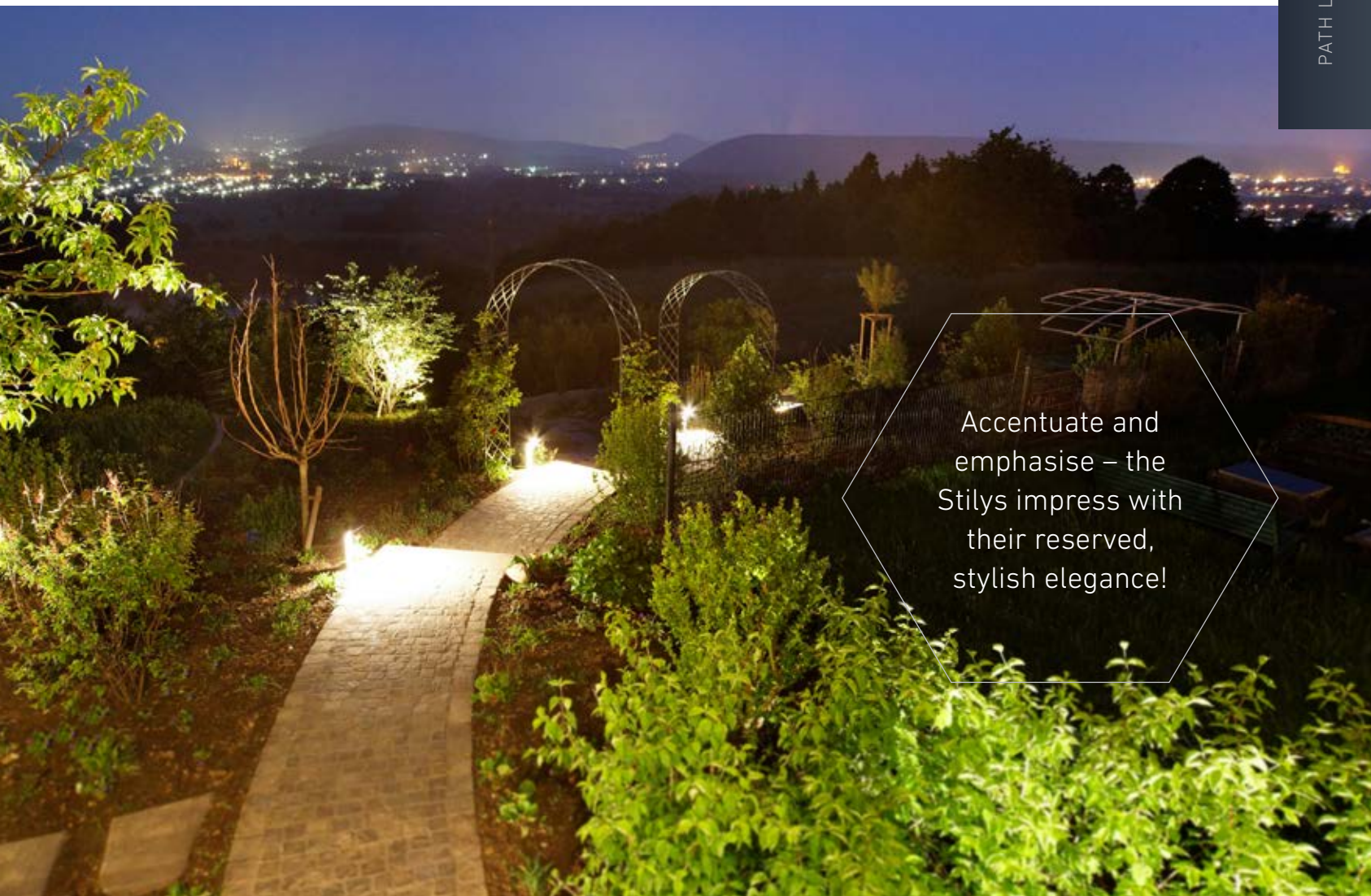

Accentuate and emphasise – the Stilyx impress with their reserved, stylish elegance!

MOUNTING ACCESSORIES
 (P. 98 – 121)
 optionally available

Ground anchor



Stilyx ES, Stilyx EM



Stilyx RM



Stilyx RS





LINEAR LUMINAIRES

Waveline	P. 78 / 79
Waveline EDGE	P. 82 / 83
Curveline	P. 84 / 85
Linear Line Micro	P. 86 / 87
Linear Line Opal	P. 88 / 89

WAVELINE

FUNCTION FOLLOWS FORM

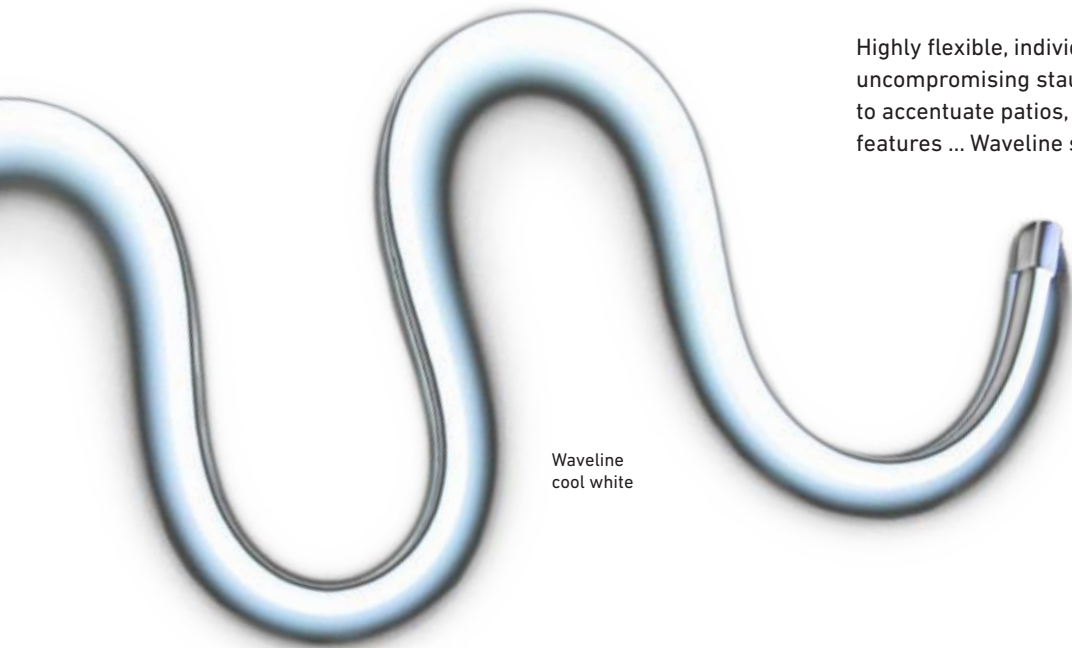

Waveline
cool white

Highly flexible, individually cut-to-length LED strip lights in uncompromising staub designlight quality. The perfect way to accentuate patios, steps, podiums, paths, pools, water features ... Waveline sets no limits to your imagination.



Waveline warm white



Waveline cool white

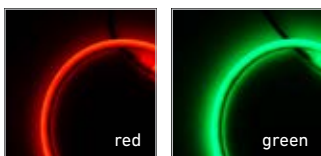

red

green

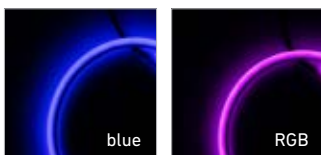

blue

RGB

Standard version

Material	Flexible strip light (suitable for undulating designs) with silicone sheathing		Length	0 – 5 m	(12 V)
Voltage	12 V DC	(0 – 5 m)	Pitch	0 – 10 m	(ww, 24 V)
	24 V DC	(ww, 0 – 10 m)		0 – 1 m	(RGB, 24 V)
	24 V DC	(RGB, 0 – 1 m)		1.65 cm	(12 V)
LED output	10 W/m	(monochrome)	3.3 cm	(24 V)	
	21.6 W/m	(RGB)	6 cm	(RGB)	
LED colour	warm white	2500 – 2700 K	Apparent power	12 W/m	(monochrome)
	cool white	6000 – 6500 K	24 W/m	(RGB)	
	red, green, blue, RGB		Installation option	4 metal clips & silicone straps per 1 m	
Light output	1300 lm/m	(warm white)	Cable length can be customised.		
Beam angle	approx. 220°				

WAVELINE LED, 12 V DC

0 – 5 m, 1 – 50 W, warm white	See price list
0 – 5 m, 1 – 50 W, cool white	See price list
0 – 5 m, 1 – 50 W, red	See price list
0 – 5 m, 1 – 50 W, green	See price list
0 – 5 m, 1 – 50 W, blue	See price list

WAVELINE LED, 24 V DC

0 – 10 m, 1 – 100 W, warm white	See price list
0 – 1 m, 1 – 21.6 W, RGB	See price list

A data sheet with detailed lighting data for each product is available to download from our website.

Subject to change without notice! Please observe the safety regulations and our terms and conditions!

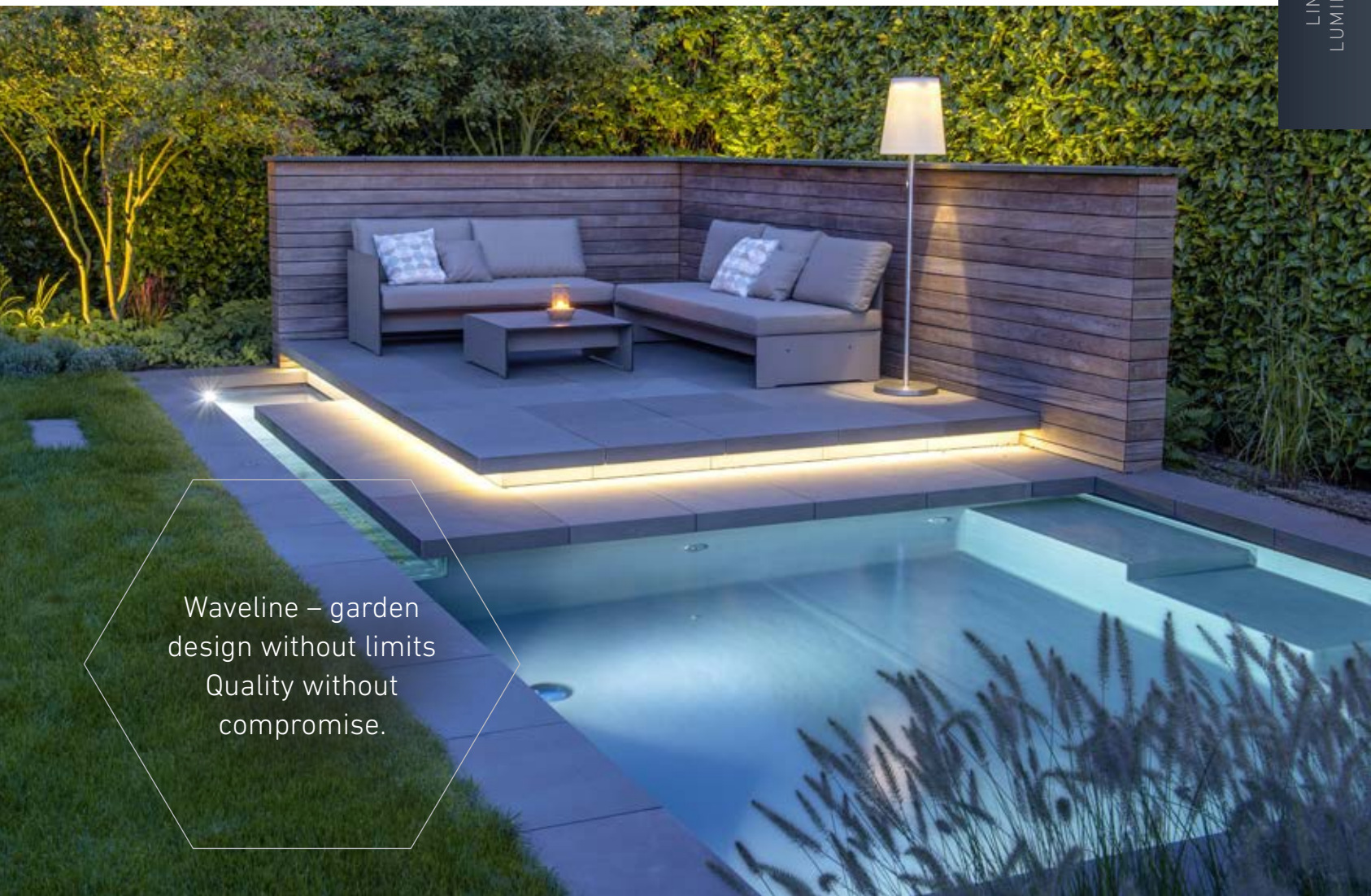

Waveline – garden design without limits
Quality without compromise.

MOUNTING ACCESSORIES (P. 98 – 121)

optionally available

U-profile, adhesive and sealants

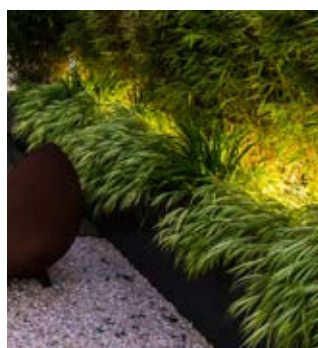
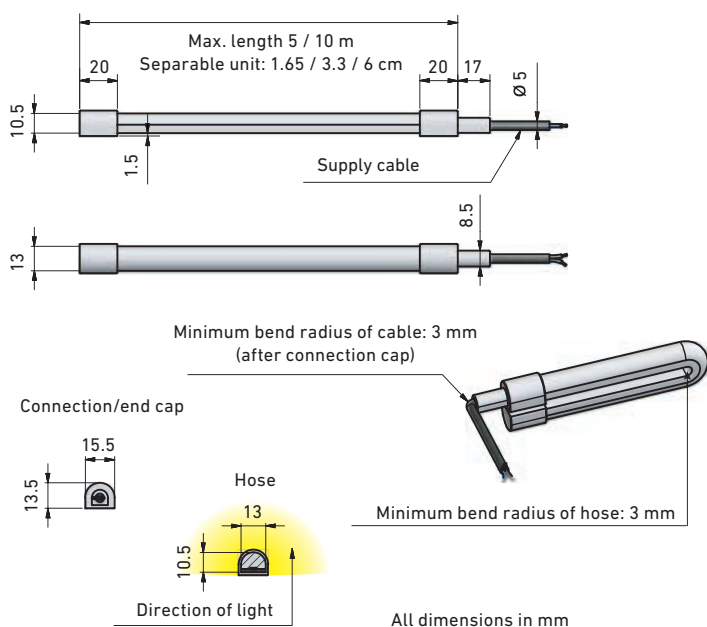

Waveline, plant lighting



Waveline, warm white



Waveline: ideal for designer edges, patio areas and much more.

TIPS & TRICKS

Sound advice from professional to professional – all in one place. Get extensive advice on lighting concepts at any time – including on site!

■ Correct selection of luminaire types

The application areas for staub designlight luminaires are manifold. To be sure you have selected the right luminaire for the desired location, be sure to carry out a light test. With our demo case you can try out every luminaire before you buy. If you would like to do a light test under water, we will gladly send you a test luminaire.



■ Correct alignment of the luminaire types

Position the Spotlight, Ultraspot, Maxispot, Megaspot and Gigaspot models in gardens or ponds so that the light does not dazzle people sitting nearby. This means the luminaires should always be directed in the opposite direction to the seating area. Lateral glare effects can easily be eliminated with the corresponding anti-glare tubes or the honeycomb anti-glare louvre (these can also be combined), which we offer as accessories.

■ Effect LEDs

The lighting produced by our Effect LEDs is most effective if the surface of the floor or wall is as smooth and even as possible. Rough wall plaster or panels with pronounced surface textures are not suitable. Instead, use the HP-LED version for these applications, as the light from these models is reflected much more widely.

■ Soft light

For very “warm” or “soft” lighting effects, use our filters or frosted-glass lenses. We can install these directly into the luminaire at your request.

■ Laying the luminaire cables

1. Route all cables from each luminaire individually to the transformer/power supply unit (star set wiring). This shortens the installation time without significantly increasing the material costs.
2. Lay all luminaire cables inside electrical conduits. This will ensure the cables are well protected in the ground. In addition, the luminaire can be easily removed in the event of a problem.
3. For recessed luminaires, a cable loop should always be included so that the luminaire can be easily opened to change the bulb.

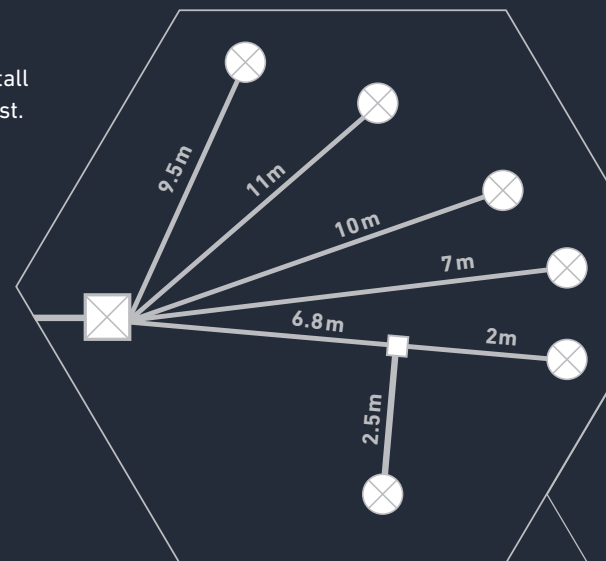



■ Cable connections

1. Be sure to encapsulate all cable connections and cable connectors. This will prevent loose contacts or drop-outs due to moisture over the long term.
2. Always clean the area of the cables to be encapsulated with acetone first. This prevents poor adhesion of the cable in the potting compound.
3. For quality reasons, always use our 2-component express potting compound. Always follow the enclosed instructions to ensure correct mixing of the potting compound.

■ Installation wrench

We supply an installation wrench as an accessory for the Ultraspot, Maxispot, Megaspot, Gigaspot, Anglespot, Superspot, Cosmospot and Honeycomb Spot. Using this practical tool, any type of luminaire can be screwed tight or unscrewed easily and with little effort. This helps to avoid leaking luminaires due to loose luminaire housings.



Cables

To avoid physical damage, all cables must be laid in electrical conduits. This also applies to underwater area inside ponds, etc.

■ Martens protection

Our standard martens protection is cast directly into the luminaire base and has a length of 40 cm. Order a longer martens-protection hose for all situations in which animals may have access to unprotected luminaire cables.

Caution: some animals may also dig up buried electric cables. Therefore lay all electrical cables inside electrical conduits.

■ Cable lengths

The maximum cable length for a light chain or star set on the 12 V AC/DC/24 V DC side, from the transformer/power supply unit to the last light, is approx. 40 metres.

To compensate for the voltage drop over long distances, we can equip the luminaires with different cable cross-sections. Another option in such cases is to position the transformer/power supply unit "closer" to the lights. To do so, however, the mains cable (230 V) must be laid in the garden. This mains cable may only be connected by a qualified electrician.

■ Transformer / power supply unit

For safe storage of the transformer/power supply unit in the garden, use a small cement shaft with a drainage bed or one of our ground installation boxes. The transformer/power supply unit can also be installed in an exposed location in the garden, however in this case the cable connections will be vulnerable to martens or other types of physical damage.

■ Cleaning your luminaires

The luminaire housings can become dull over time when used above water. Use our cleaning and care kit to clean your luminaires.

When used underwater, the luminaire housings will become contaminated by lime, algae, etc. Submerge the entire, closed luminaire in a mild descaling agent for 2 – 3 minutes. Then rinse off the loosened dirt thoroughly.

■ Leaking luminaires

If moisture or water has penetrated inside a luminaire, the cause of the fault must first be determined. If it was not closed tightly enough, it must be cleaned inside and dried with a warm air dryer. Lightly coat any rusty luminaire contacts with an electrical-contact cleaning spray. Check the connection cable for physical damage and if necessary repair it, ensuring that it is once again waterproof.



WAVELINE EDGE

FASCINATING LIGHT PATTERNS

The straight, clear, linear beams create exciting lighting moods. Thanks to the luminaire's homogeneous surface, no individual points of light are visible. Custom lengths are available!



Waveline EDGE
in U-profile

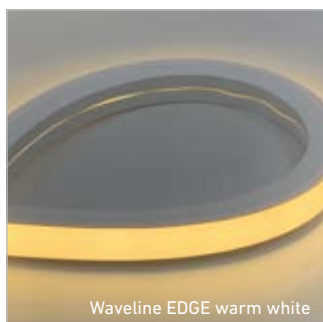

Waveline EDGE warm white



Waveline EDGE cool white

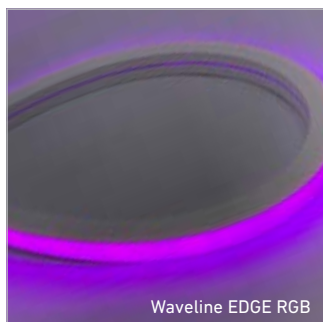

Waveline EDGE RGB



Standard version

Material	Flexible strip light (suitable for undulating designs) with silicone sheathing	
Voltage	24 V DC	
LED output	10 W/m	(ww, kw) 21.6 W/m (RGB)
LED colour	warm white	2900 – 3100 K
	cool white	6000 – 6500 K
	RGB	
Light output	760 lm/m	(warm white)
Beam angle	approx. 120°	

Length	0 – 10 m
	Made to measure
Pitch	every 5 cm
Apparent power	12 W/m (ww, kw) 24 W/m (RGB)
Cable length can be customised.	

WAVELINE EDGE LED, 24 V DC	
0 – 10 m, 1 – 100 W, warm white	See price list
0 – 10 m, 1 – 100 W, cool white	See price list
0 – 10 m, 1 – 216 W, RGB	See price list

A data sheet with detailed lighting data for each product is available to download from our website. Subject to change without notice! Please observe the safety regulations and our terms and conditions!

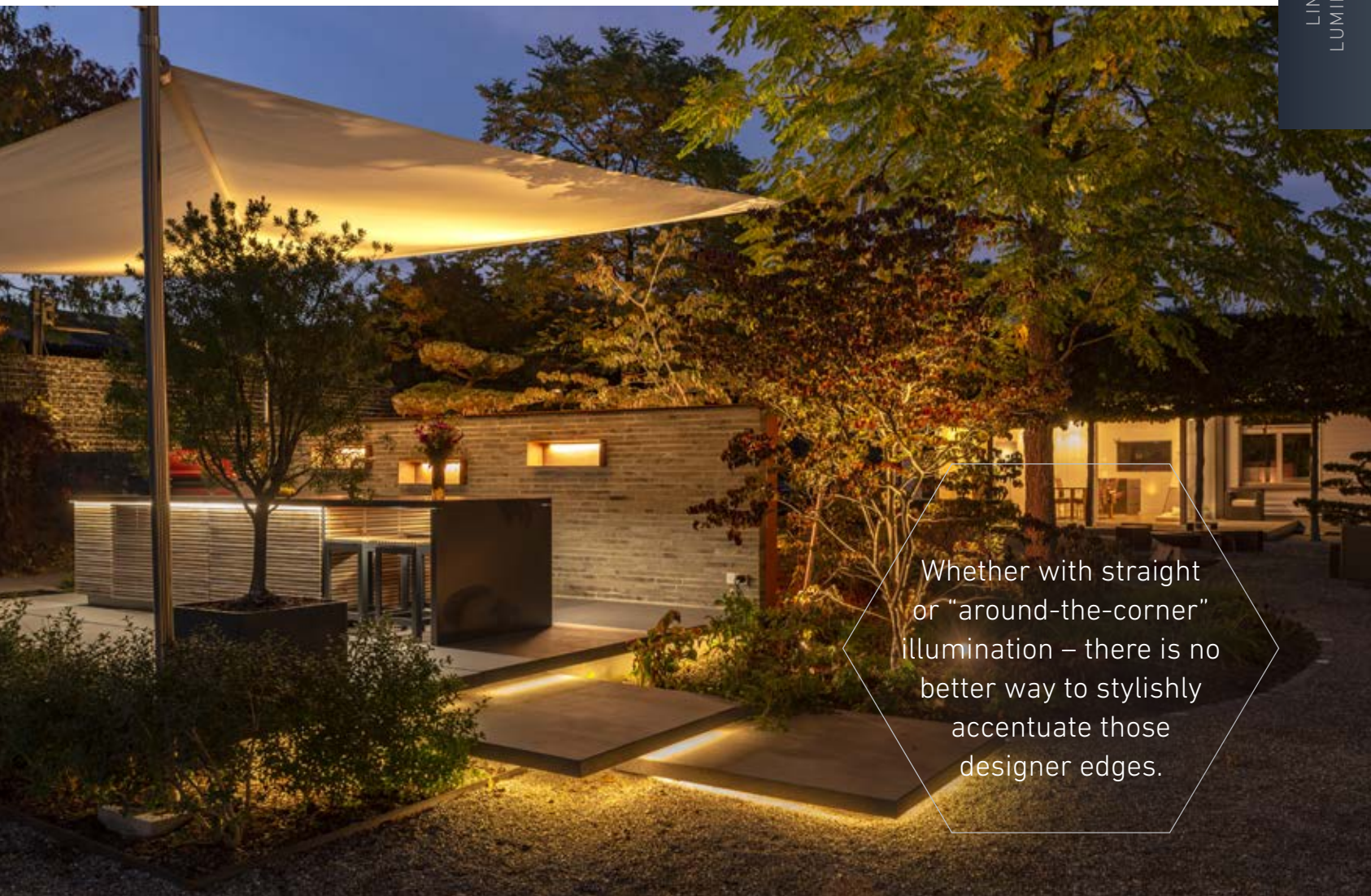

Whether with straight or “around-the-corner” illumination – there is no better way to stylishly accentuate those designer edges.

MOUNTING ACCESSORIES (P. 98 – 121)
 optionally available
 U-profile, adhesive and sealants

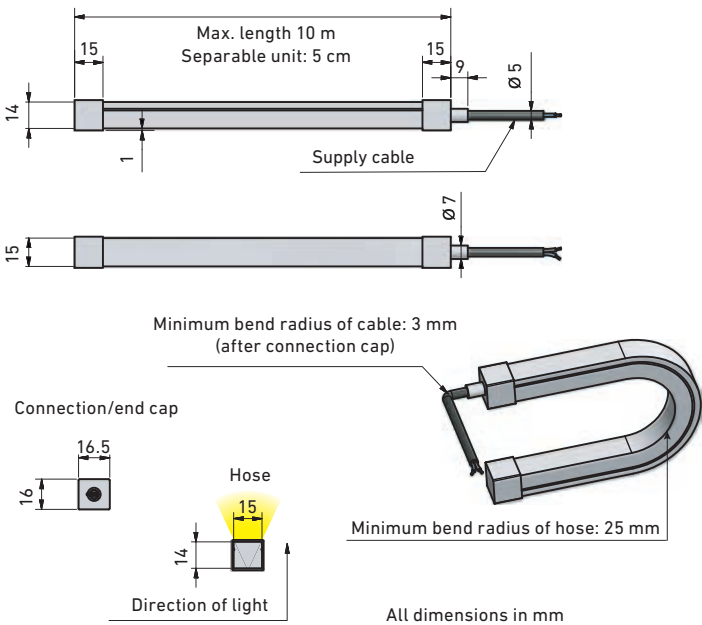

Waveline EDGE, path lighting



Waveline EDGE, object presentation



Waveline EDGE, outdoor lighting

CURVELINE

A THING OF BEAUTY.

Lines of light that bend gently and provide an absolutely homogeneous lighting effect without visible points – the perfect way to create highlights in gardens and on installations!

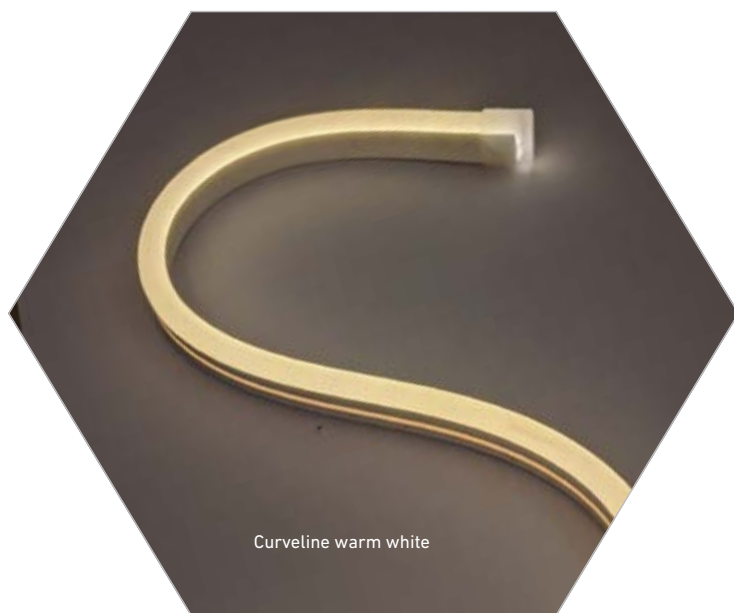

Curveline warm white



Curveline cool white

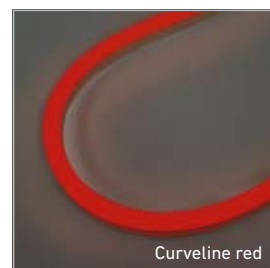

Curveline red



Curveline green



Curveline blue



Standard version

Material	Flexible strip light (suitable for curved designs) with silicone sheathing	
Voltage	12 V DC	
LED output	10 W/m	
LED colour	warm white	2900 – 3100 K
	cool white	6000 – 6500 K
	red, green, blue	
Light output	480 lm/m	(warm white)
Beam angle	approx. 160°	

Length	0 – 5 m	(power supply at one end)
	5 – 10 m	(power supply at both ends)
	Made to measure	
Pitch	every 2.5 cm is possible	
Apparent power	11 W/m	
Installation option	4 clips per 1 m	
Cable length can be customised.		

CURVELINE LED, 12 V DC	Power supply at one end 0 – 5 m, 0 – 50 W	Power supply at both ends 5 – 10 m, 50 – 100 W
warm white	See price list	See price list
cool white	See price list	See price list
red	See price list	See price list
green	See price list	See price list
blue	See price list	See price list

A data sheet with detailed lighting data for each product is available to download from our website.
Subject to change without notice! Please observe the safety regulations and our terms and conditions!

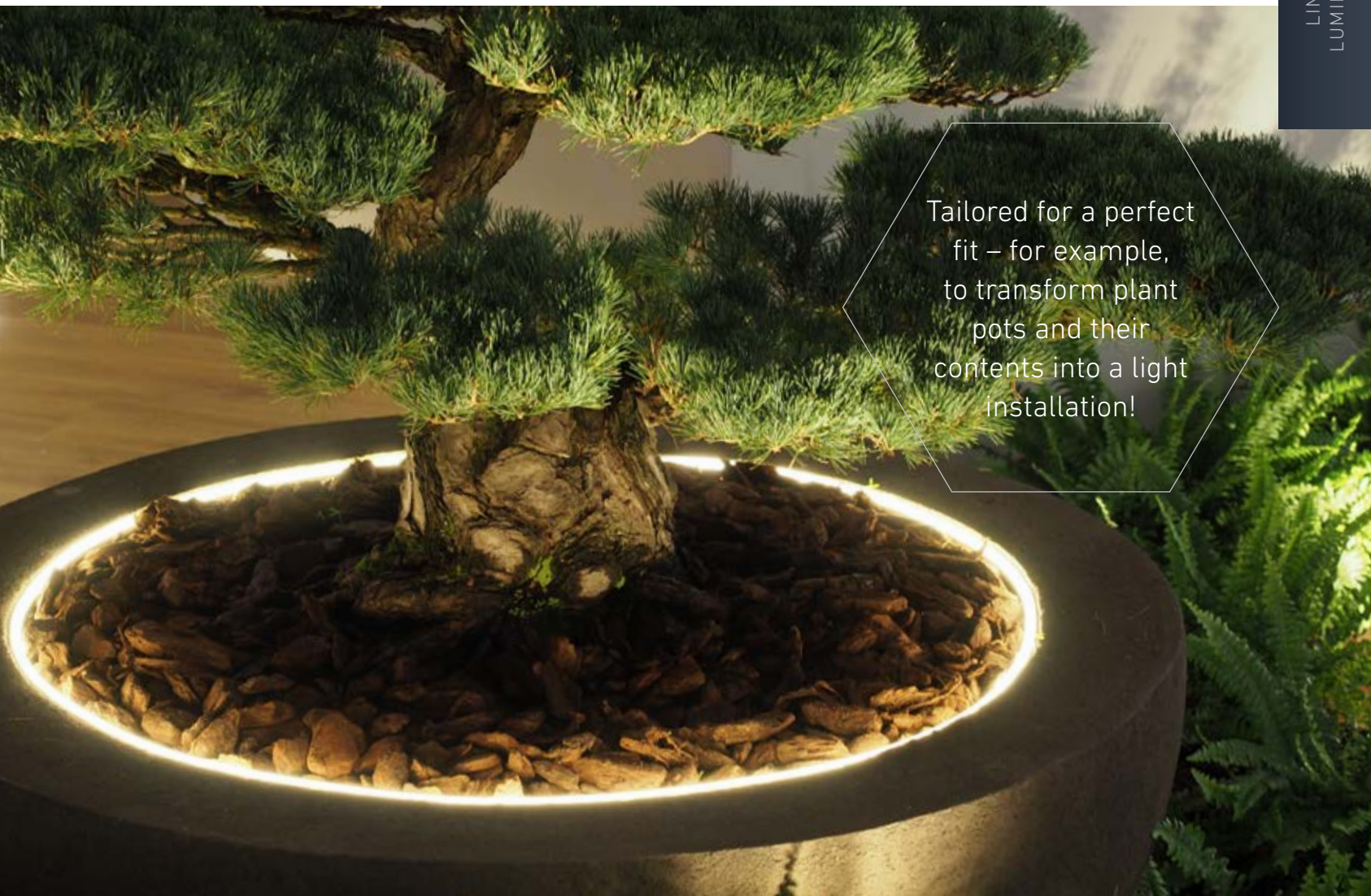

Tailored for a perfect fit – for example, to transform plant pots and their contents into a light installation!

MOUNTING ACCESSORIES (P. 98 – 121)
optionally available
Adhesives and sealants

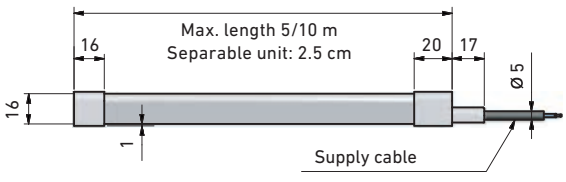

Curvilinear clips

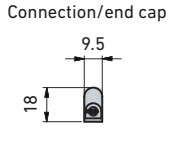
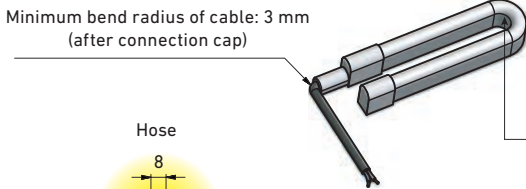

All dimensions in mm

LINEAR LINE MICRO

ROBUST LIGHTING DESIGNS

Amazing light effects guaranteed! The Linear Line Micro impresses thanks to dozens of extra-bright LED light points as well as excellent workmanship.



Linear Line Micro

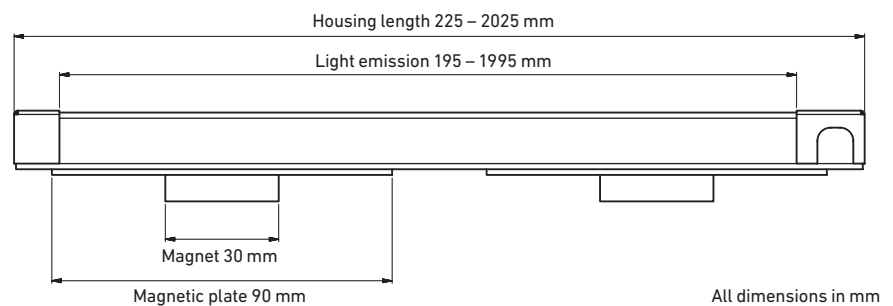

Standard version

Material	V4A, profile ist potted transparently	
Voltage	12 V DC	
LED output	20 W/m	
LED colour	warm white	2700 K
Beam angle	approx. 80°	
Housing length	225 – 2025 mm (in 200 mm grid)	
Housing width	21.2 mm	
Depth	24 mm 15.5 mm without magnet system	
Cable exits	L1/R3, L2/R2, L3/R1	
Light output	492 lm/m	
Apparent power	21 W/m	
Installation option	Magnet system	

Special design

LED colour	RGB	
Luminaire options	without martens protection, without magnet system Special length as per customer requirements	
Cable length and martens protection can be customised.		

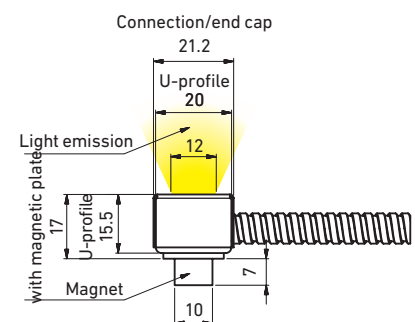

LINEAR LINE MICRO, 12 V DC, WITH MAGNET SYSTEM	
Housing length 225, 4 W, warm white	20.250300
Housing length 425, 8 W, warm white	20.250301
Housing length 625, 12 W, warm white	20.250302
Housing length 825, 16 W, warm white	20.250303
Housing length 1025, 20 W, warm white	20.250304
Housing length 1225, 24 W, warm white	20.250305
Housing length 1425, 28 W, warm white	20.250306
Housing length 1625, 32 W, warm white	20.250307
Housing length 1825, 36 W, warm white	20.250308
Housing length 2025, 40 W, warm white	20.250309
SA, special design, made to order	20.250310

A data sheet with detailed lighting data for each product is available to download from our website.
Subject to change without notice! Please observe the safety regulations and our terms and conditions!

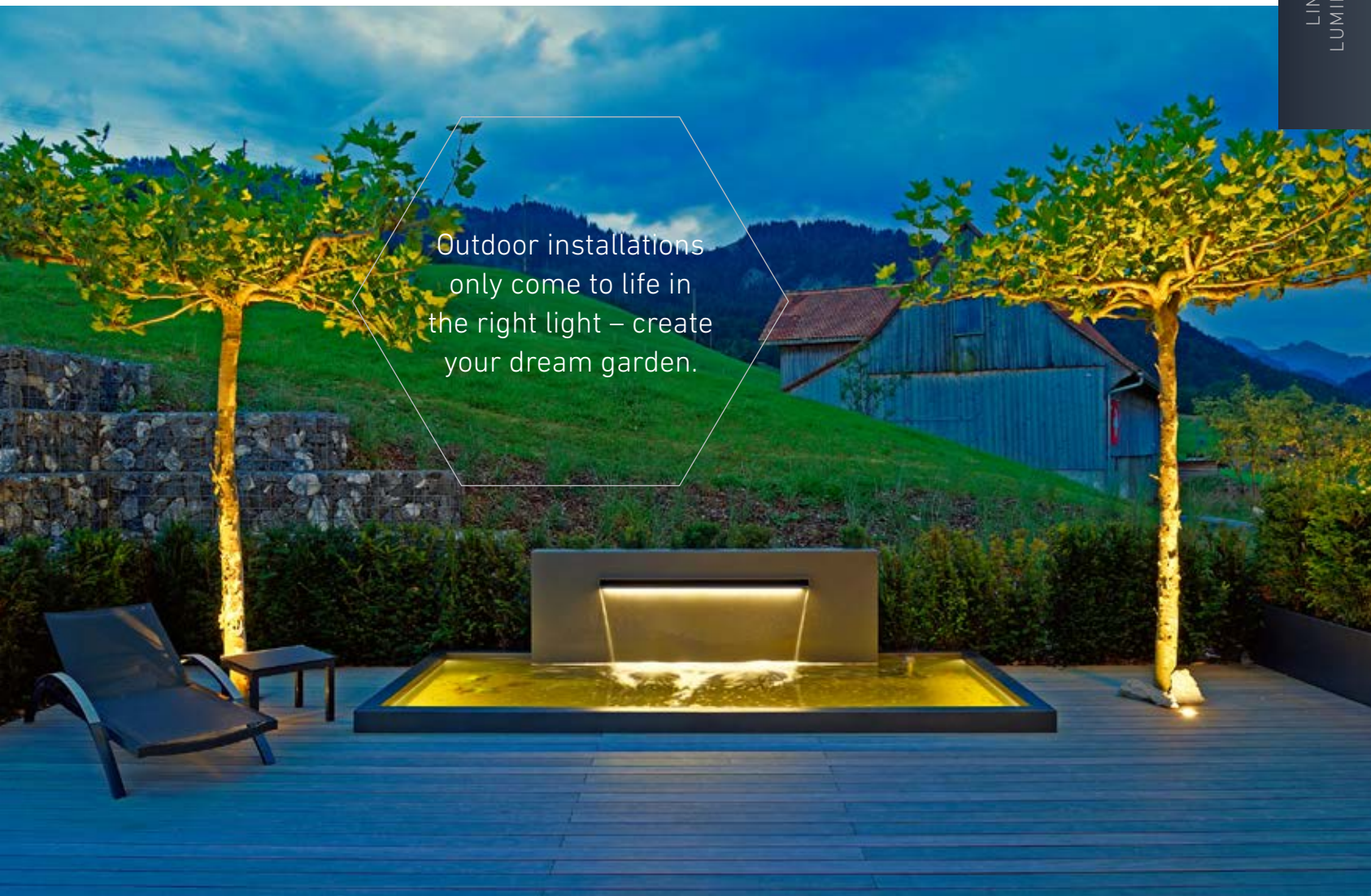

Outdoor installations only come to life in the right light – create your dream garden.

MOUNTING ACCESSORIES
 (P. 98 – 121)
 optionally available
 Mounting adapter on luminaire holder, adhesive and sealant



Linear Line Micro, fountain lighting



Linear Line Micro, step lighting

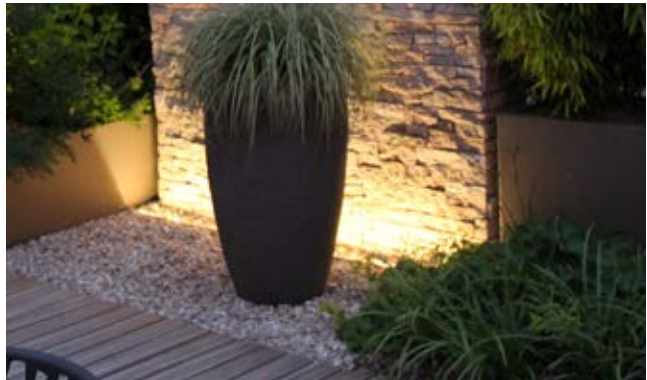

Linear Line Micro, accent lighting



Linear Line Micro, RGB

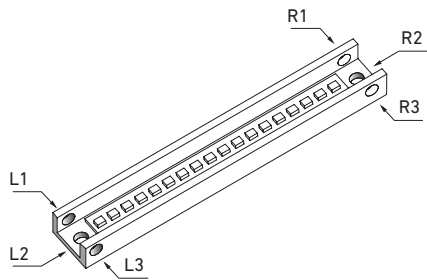

Possible cable exits

LINEAR LINE OPAL

EXTREMELY ROBUST

The Linear Line Opal is characterised by extreme stability and robustness! Ideal for use in exposed locations. Can be installed close to the ground.



Linear Line Opal with stainless steel bezel



Linear Line Opal with stainless steel panel

Standard version

Voltage	12 V DC
LED output	20 W/m
LED colour	warm white 2700 K
Beam angle	approx. 110°
Light output	233 lm/m
Apparent power	21 W/m

Special design

LED colour RGB

Cable length can be customised.

MOUNTING ACCESSORIES

(P. 98 – 121)

optionally available

Adhesives and sealants



with stainless steel bezel



with stainless steel panel

LINEAR LINE OPAL, 12 V DC, STAINLESS STEEL BEZEL

Housing length 225, 4 W, warm white	20.250400
Housing length 425, 8 W, warm white	20.250401
Housing length 625, 12 W, warm white	20.250402
Housing length 825, 16 W, warm white	20.250403
Housing length 1025, 20 W, warm white	20.250404

LINEAR LINE OPAL, 12 V DC, WITH STAINLESS STEEL PANEL

Housing length 240, 4 W, warm white	20.250410
Housing length 440, 8 W, warm white	20.250411
Housing length 640, 12 W, warm white	20.250412
Housing length 840, 16 W, warm white	20.250413
Housing length 1040, 20 W, warm white	20.250414

A data sheet with detailed lighting data for each product is available to download from our website.

Subject to change without notice! Please observe the safety regulations and our terms and conditions!

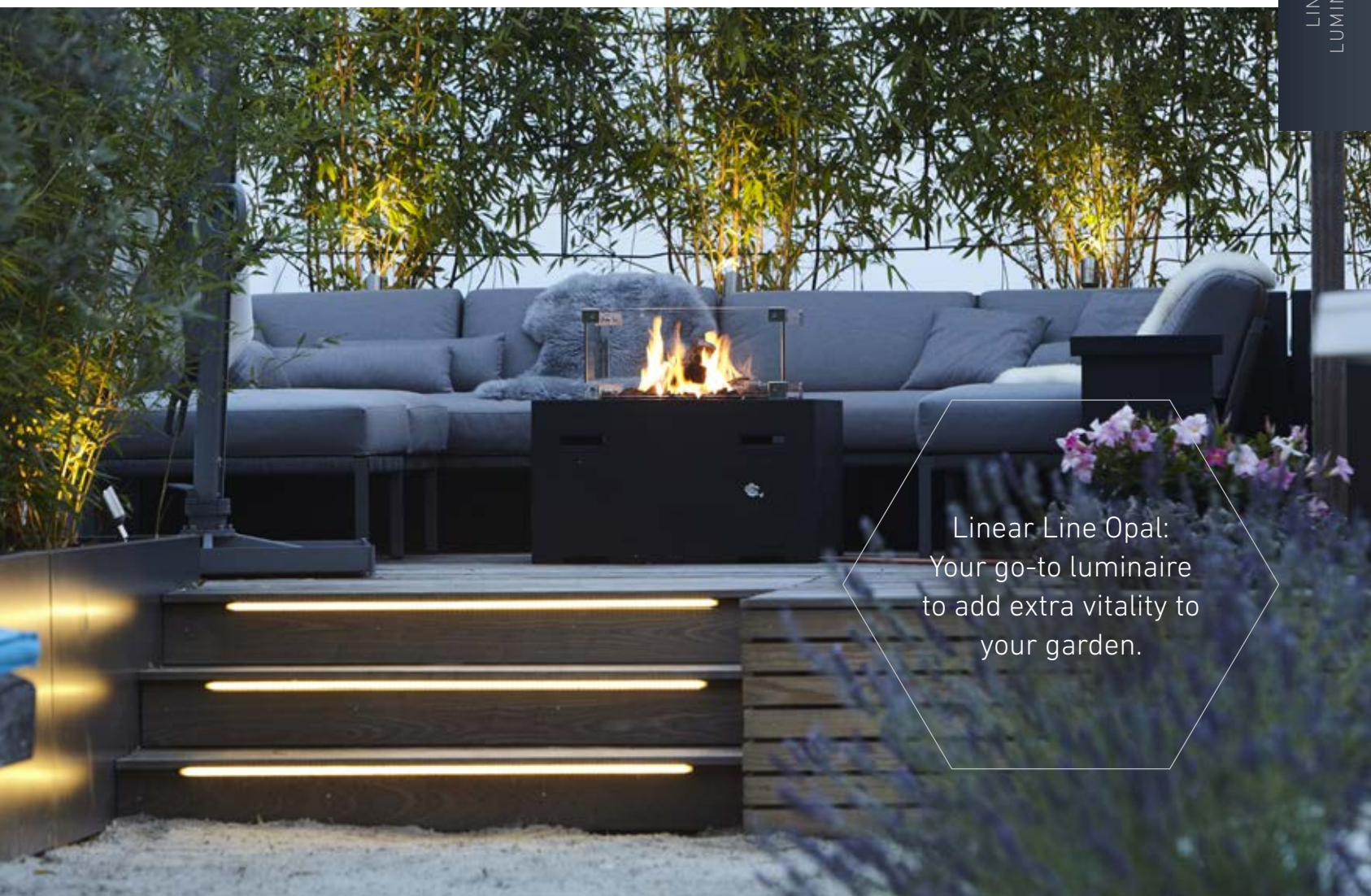

Linear Line Opal:
Your go-to luminaire
to add extra vitality to
your garden.

Linear Line Opal
with stainless steel bezel

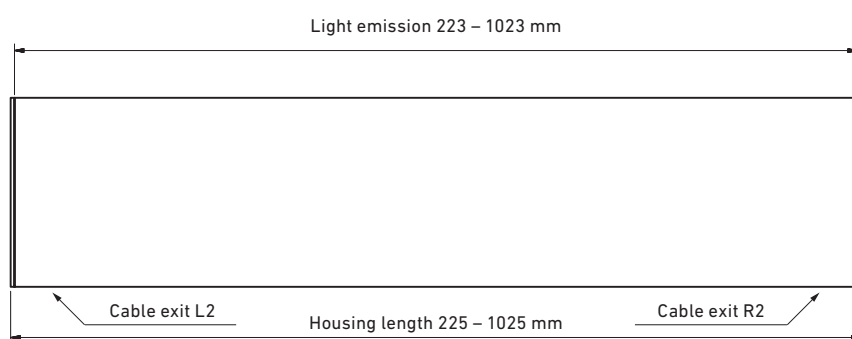
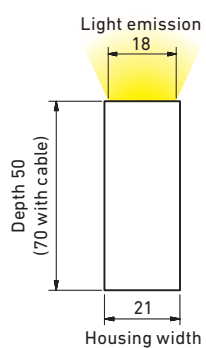

Linear Line Opal
with stainless steel panel

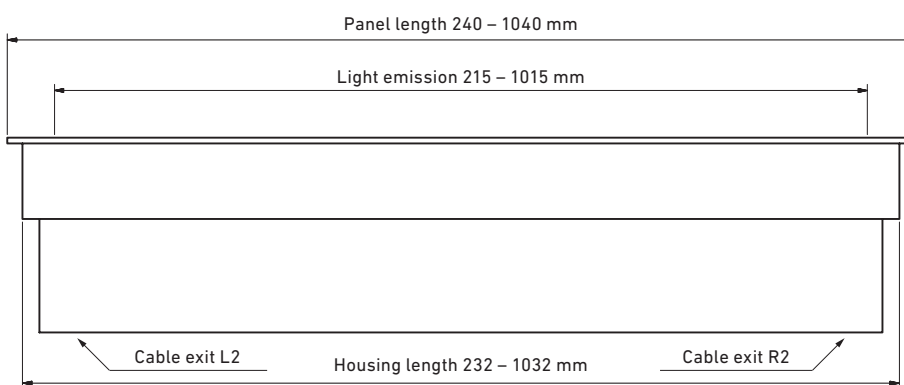
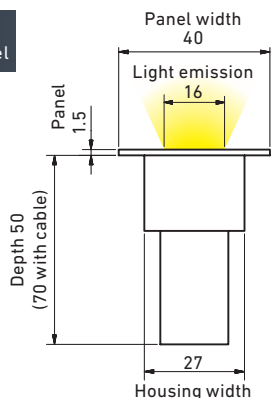

All dimensions in mm





POOL LUMINAIRES

Block Light

P. 92 / 93

Megaspot Pool

P. 94 / 95

BLOCK LIGHT

BATHED IN THE BEST LIGHT

The ideal luminaire on water issues. Strong luminance with a wide range of installation options and applications!



Block Light
stainless steel

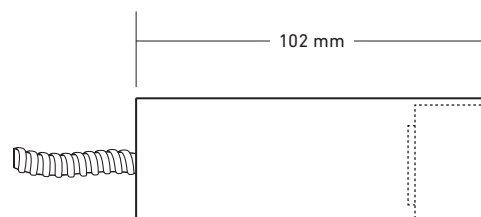
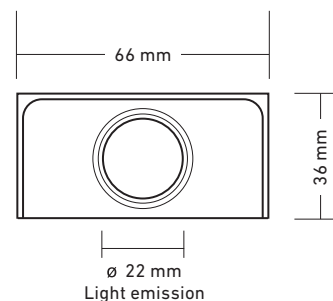

Standard version

Voltage	12 V AC/DC	
LED output	1 W	
LED colour	warm white	2700 K
Beam angle	44° x 12°	
Light output	150 lm	
Apparent power	2.5 W	

Special design

LED colour	warm white	3000 K
	cool white	6000 K
Beam angle	10°, 20°, 30°	
Lighting accessories (optional)	Warm-light filter, frosted glass	
Cable length and martens protection can be customised.		

BLOCK LIGHT HP-LED, 12 V AC/DC		Stainless steel
1 W, 44° x 12°, warm white		20.661000

A data sheet with detailed lighting data for each product is available to download from our website.
Subject to change without notice! Please observe the safety regulations and our terms and conditions!

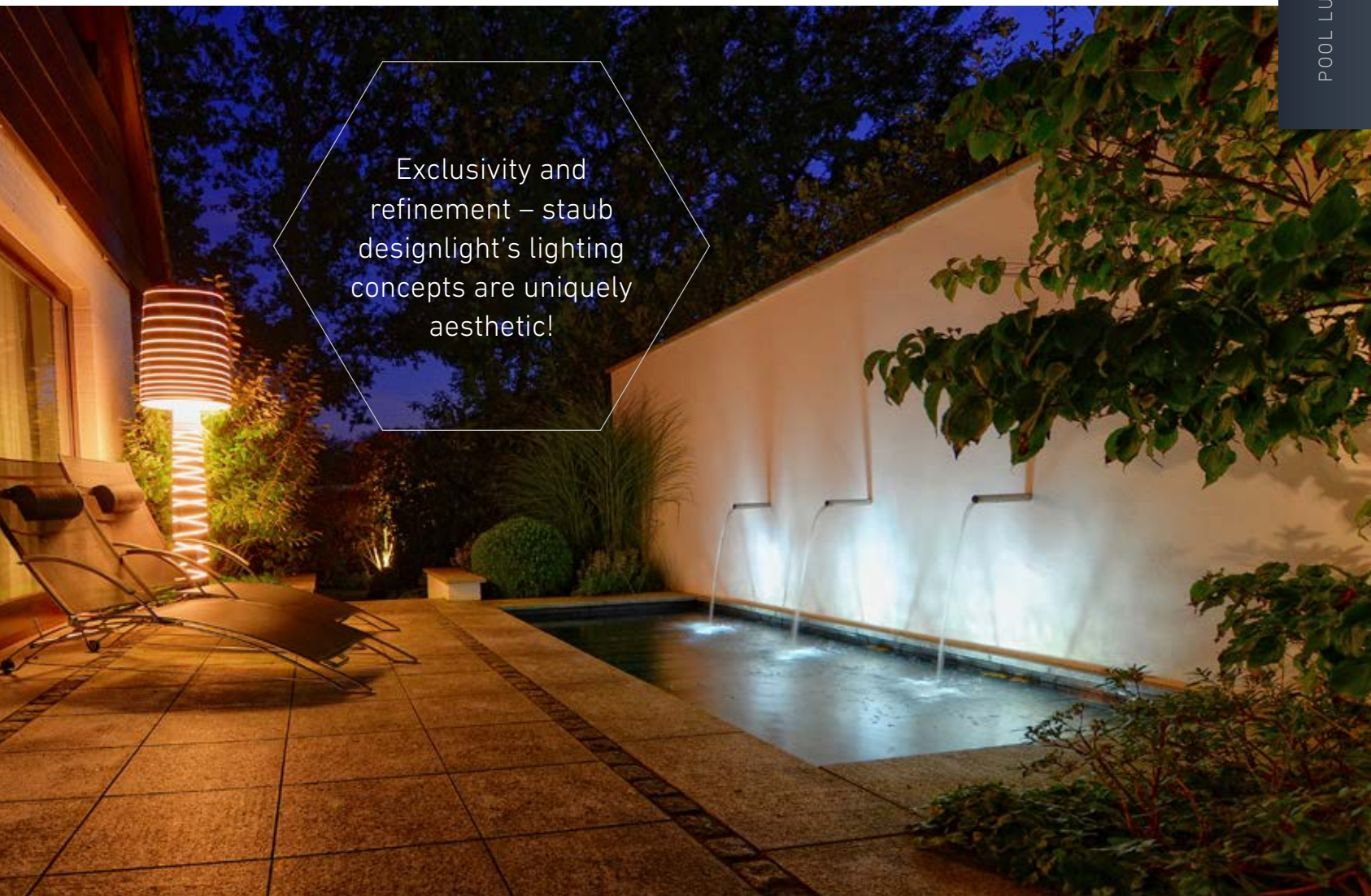

Exclusivity and refinement – staub designlight's lighting concepts are uniquely aesthetic!

ACCESSORIES

(P. 98 – 121)

optionally available

Adhesives and sealants

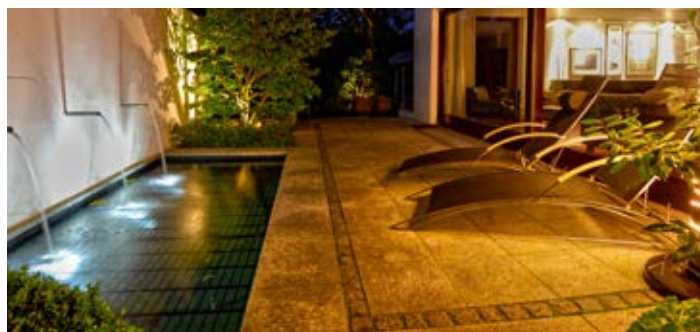

Block Light in pools and tanks



Block Light



Block Light – for perfect illumination of pools and tanks

MEGASPOT POOL

AWASH WITH LIGHT

Water is a key element when it comes to creating exclusive and lavish designs. When water is illuminated, magical moments and unique experiences are created.

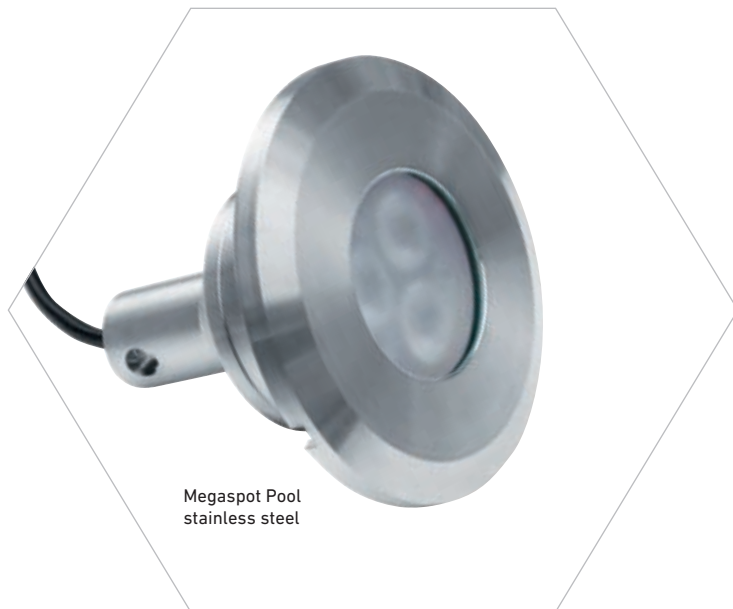

Megaspot Pool stainless steel

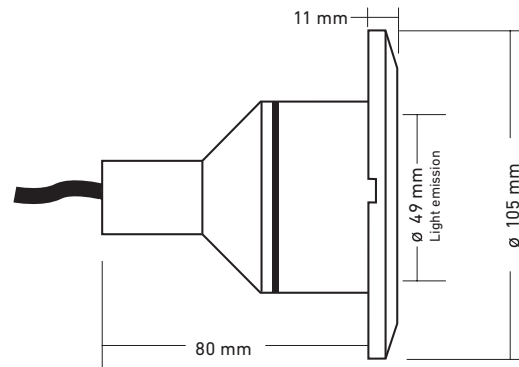

Hexagonal insert

LED MODULE
replaceable



Standard version

Voltage	12 V AC/DC	(warm white)
Current	0.4 A	(RGBW)
LED output	9 W	(warm white)
	12 W	(RGBW)
LED colour	warm white	2700 K
	RGBW	4000 K
Beam angle	14°, 20°, 40°	
Light output	675 lm	(warm white)
Apparent power	11.5 W	(warm white)
	15 W	(RGBW)

Special design

LED colour	warm white	3000 K
	cool white	6200 K
Cable length can be customised.		



Mounting box for metal and plastic pools



Mounting box for film-lined pools

MEGASPOT POOL HP-LED, 12 V AC/DC		
9 W, 14°, warm white, with frosted glass		20.166019
9 W, 20°, warm white, with frosted glass		20.166020
9 W, 40°, warm white, with frosted glass		20.166021
MEGASPOT POOL RGBW, 0.4 A		
12 W, 14°, RGBW, with frosted glass		20.166024
12 W, 20°, RGBW, with frosted glass		20.166025
12 W, 40°, RGBW, with frosted glass		20.166018

A data sheet with detailed lighting data for each product is available to download from our website.
Subject to change without notice! Please observe the safety regulations and our terms and conditions!

The Megaspot Pool bathes every pool in a magical light – with unrivalled flexibility.

ACCESSORIES (P. 98 – 121)

optionally available

Mounting box for metal and plastic pools, mounting box for film-lined pools, hex insert No. 19 (3/8"), adhesive and sealing compound

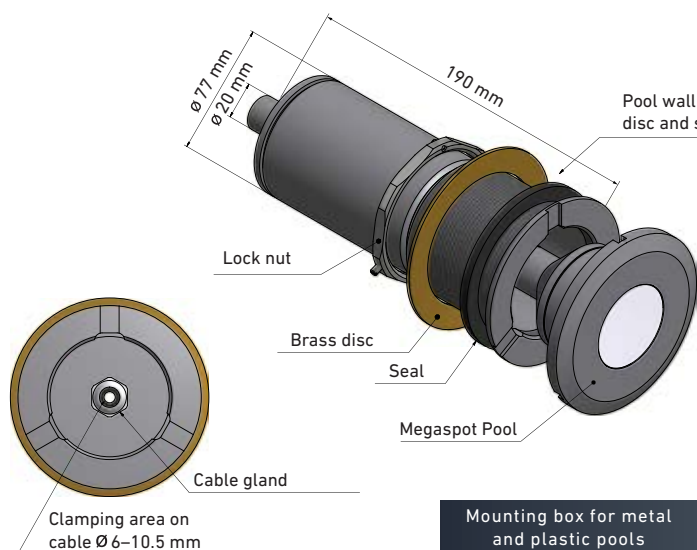

Mounting box for metal and plastic pools

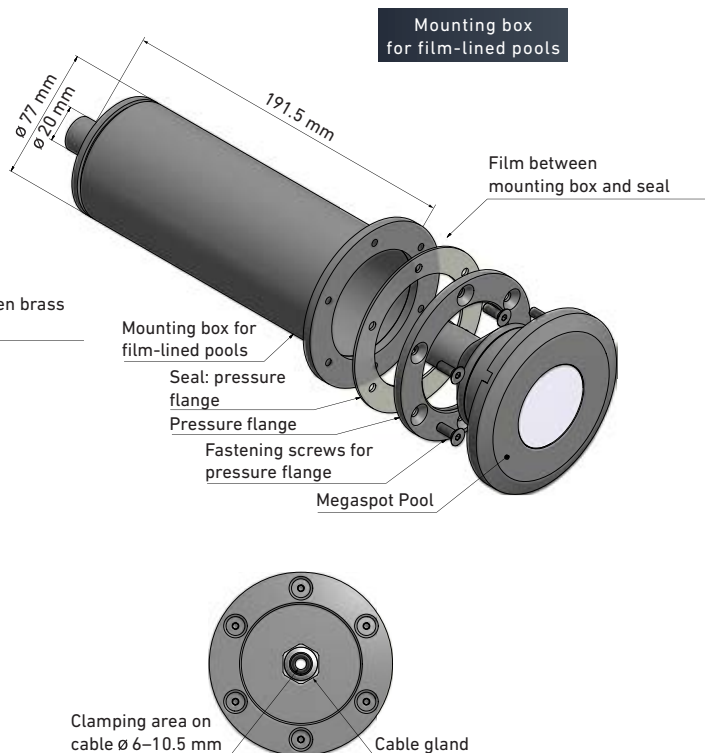

Mounting box for film-lined pools



AS THE DAY DRAWS TO A CLOSE, STAUB DESIGNLIGHT TURNS ON THE LIGHTS.

staub designlight – the first choice for atmospheric
gardens, pools and outdoor installations.



Extend your outdoor living space even after sunset – with the perfect lighting from staub designlight.

7 YEARS WARRANTY

on all staub designlight luminaires

IP 68-TESTED

100% waterproof



IN-HOUSE PRODUCTION

Swiss quality product







SMART ACCESSORIES

Power supply

Control units

Installation accessories

Lighting accessories

P. 102 / 103

P. 104 – 107

P. 108 / 109

P. 110 / 111

Ground installation accessories

Installation materials

Spare parts

P. 112 / 113

P. 114 – 117

P. 118 – 121

ACCESSORIES THAT ARE A PERFECT FIT!

INSTALLATION

Base plate

P. 109



Luminaire holders

P. 108

POWER SUPPLY

Power supply units

P. 103



Transformers

P. 102



CONTROL UNIT

Handheld transmitter,
42-channel

P. 104



2.4GHz RGBW
control units

P. 106



Radio built-in switch,
2-channel set

P. 105



LIGHTING ACCESSORIES

Tubular glare guard

S. 111



Frosted glass &
warm-light filters

P. 110

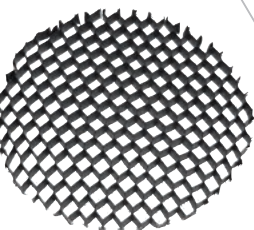

Honeycomb anti-glare
louvre

P. 111

INSTALLATION



Ground installation box
P. 114



Installation wrench
P. 115



Martens protection braid
P. 114



Cable connection
P. 116



HP-LED module
P. 121



Lenses and reflectors
P. 120



Ground anchor
P. 113



Mounting box
P. 113



Assembly sleeve
P. 112



Mounting tube
P. 112

SPARE PARTS



Sealing rings
P. 119



Adhesives and sealants
P. 117

GROUND INSTAL-LATION

TRANSFORMERS

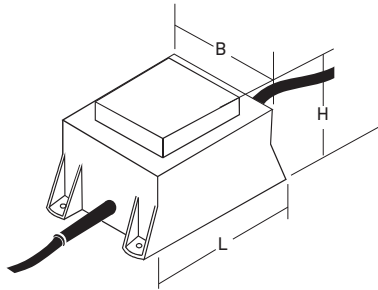

Transformer dimensions

All transformers can be used outdoors (but not under water). They fully comply thermally and electrically with the European EN standard 61558-2-6:2010.

Standard version: power cable: 2 m with plug, light cable: 0.5 m with loose end; each transformer is protected with a replaceable fuse; built-in thermal switch against overheating.



Iron-core transformer

Toroidal transformer

- Very high-quality, double-insulated safety transformer with iron core
- Very robust, moulded polyamide housing
- Especially high degree of efficiency



ACCESSORIES

(P. 114)
optionally available

Ground installation box



TRANSFORMERS (IP67), input: 230 VAC/50Hz

Type	Output	Fuse	Length [mm]	Width [mm]	Height [mm]	
Transformer 20 VA	12 V AC	T500 mA	100	75	75	20.120520
Transformer 40 VA	12 V AC	T630 mA	130	90	80	20.124560
Transformer 70 VA	12 V AC	T800 mA	130	90	90	20.124570
Transformer 105 VA	12 V AC	T1.25 A	130	90	105	20.120105
Transformer 200 VA	12 V AC	T2.5 A	180	110	130	20.126013
Transformer 300 VA	12 V AC	T4.0 A	180	110	130	20.126300

TOROIDAL TRANSFORMER (IP54), input: 230 VAC/50Hz

Toroidal transformer 105 VA	12 V AC	T1.25 A	Ø 110 mm	Height 50 mm	20.120106
-----------------------------	---------	---------	----------	--------------	-----------

A data sheet with detailed lighting data for each product is available to download from our website.
Subject to change without notice! Please observe the safety regulations and our terms and conditions!

POWER SUPPLY UNITS



With integrated potentiometer



With integrated DALI dimmer



These power supply units are suitable for almost all **staub designlight** luminaires

- High-quality power supply units, 12 or 24 V DC
- Waterproof, built into polyethylene housing
- Also available with potentiometer or integrated DALI LED dimmer

All power supply units are installed in a PE protective housing and can be used outdoors (but not under water). Power cable: 2 m with plug, light cable: 0.5 m with loose end.

Standard: Non-adjustable power supply unit

Potentiometer: Power supply unit with integrated potentiometer, adjustable (10 – 100%). Attention: not suitable for all luminaire types.

DALI dimmer: power supply unit with built-in Lunatone DALI LED dimmer, output controllable via DALI or Sw&Dim/SwitchDim2, cable 3-pole 0.5 m



ACCESSORIES

(P. 114)
optionally available

Ground installation box



POWER SUPPLY UNITS 12 V DC (IP67), input: 230 VAC/50Hz

Type	Output	Dimensions [mm]	Standard	potentiometer	DALI dimmer
Power supply unit 40 W	12 V DC	Ø 78 x 270	20.126041	20.126040	20.126042
Power supply unit 100 W	12 V DC	Ø 93 x 285	20.126121	20.126120	20.126122
Power supply unit 150 W	12 V DC	Ø 93 x 310	20.126151	20.126150	20.126152

POWER SUPPLY UNITS 24 V DC (IP67), input: 230 VAC/50Hz, only for Waveline 24 V

Power supply unit 100 W	24 V DC	Ø 78 x 270	20.124100	20.124101	20.124102
Power supply unit 200 W	24 V DC	Ø 93 x 285	20.124200	20.124201	20.124202
Power supply unit 300 W	24 V DC	Ø 93 x 310	20.124300	20.124301	20.124303

RADIO REMOTE CONTROLS

ON/OFF

Ideal for switching all lights on/off

Installation: The units are ideal for water-protected surface or flush mounting. They are connected directly to the electrical supply line. The installation/connection may only be carried out by a qualified electrician.

Technical specification:

Power supply	230 V AC
Degree of protection	IP20
Dimensions	54 x 49 x 25 mm

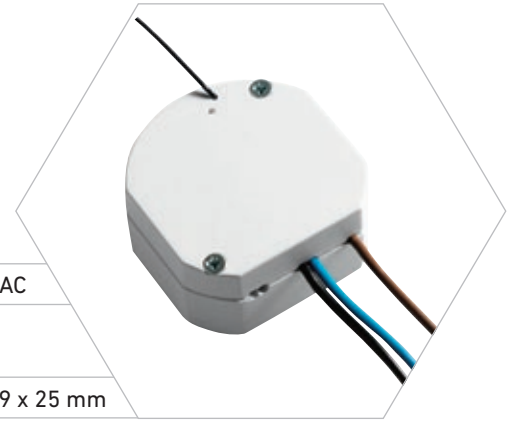

RADIO BUILT-IN SWITCH	
1 channel, on/off switching function, max. 1000 W	20.230300



WATER-PROTECTED ON/OFF

Ideal for switching all lights on/off

Installation: outdoors in shafts of all kinds with appropriate humidity.

The radio switch must be positioned in the upper area of the shaft for good radio reception.

Technical specification:

Power supply	Input 230 V AC, 0.3 m power cable with plug
	Output 230 V AC per channel: 0.3 m power cable with coupling
Degree of protection	IP54 (splash-proof)

RADIO SWITCH	
1 channel , on/off switching function, max. 1000 W, 80 x 80 x 52 mm (LxWxH)	20.230301
2-channel , on/off switching function, max. 2 x 3400 W, 230 x 145 x 85 mm (LxWxH)	20.230303
4-channel , on/off switching function, max. 4 x 1000 W, 200 x 180 x 79 mm (LxWxH)	20.230302

HANDHELD TRANSMITTER

Universal radio handheld transmitter with wall mounting, ideal for group commands. Up to 42 groups can be controlled individually with the option to managing up to 6 lighting scenes.

Suitable for all on/off switches and dimmers.



Handheld mini transmitter, black with aluminium satin finish. Up to 2 groups can be controlled individually.

Technical specification:

Power supply	3 V ± 10%
Lithium battery	CR2032
Degree of protection	IP20
Dimensions	60 x 30 x 10 mm



RADIO HANDHELD TRANSMITTER	
Handheld transmitter, 42-channel, white, including wall mounting and battery	20.230330

RADIO HANDHELD TRANSMITTER	
Mini handheld transmitter, 2-channel, including battery	20.230334

A data sheet with detailed lighting data for each product is available to download from our website. Subject to change without notice! Please observe the safety regulations and our terms and conditions!

ON/OFF SET WITH REMOTE CONTROL AND WALL SWITCH

WALL SWITCH

Wall switch for group commands. Allows 1 to 4 groups to be controlled individually.

Installation: with screws or double-sided adhesive tape on walls, glass, tiles, wood, etc.

Technical specification:

Power supply	3 V ± 10%
Lithium battery	CR2430
Degree of protection	IP20
Dimensions	86 x 86 x 9.5 mm



RADIO WALL SWITCH	
1-channel, white, battery included	20.230331
2-channel, white, battery included	20.230332
4-channel, white, battery included	20.230333



Ideal for switching all lights on/off

Installation: outdoors in shafts of all kinds with appropriate humidity.

The radio switch must be positioned in the upper area of the shaft for good radio reception.

Technical specification:

Power supply	Input 230 V AC, 0.3 m power cable with plug
	Output 230 V AC per channel: 0.3 m power cable with coupling
Degree of protection	IP54 (splash-proof)

RADIO SWITCH SET	
2 channel , on/off switching function, with remote control and wall switch, max. 2 x 3400 W, 230 x 145 x 85 mm (LxWxH)	20.230310
4 channel , on/off switching function, with remote control and wall switch, max. 4 x 1000 W, 200 x 180 x 79 mm (LxWxH)	20.230311

PWM DIMMER

Ideal for dimming all lights with constant voltage 12/24 V DC

Installation: outdoors in shafts of all kinds with appropriate humidity.

The radio switch must be positioned in the upper area of the shaft for good radio reception.

Technical specification:

Power supply	12/24 V DC
Possible outputs	3
Output	50 W per output (12 VDC) 100 W per output (24 VDC)
Degree of protection	IP54 (splash-proof)
Dimensions	240 x 70 x 50 mm



PWM DIMMER (RADIO)	
3 channel, PWM dimming function, 3 x 50 W / 3 x 100 W	20.230326

2.4GHZ CONTROL UNITS

2.4GHZ RGBW CONTROL BOXES

The control boxes compatible with Maxispot, Superspot, Superspot Compact, Megaspot, Cosmospot, Honeycomb Spot and Megaspot Pool RGBW.

- Operation via handheld/wall transmitter or optional 2.4GHz gateway with app
- Timer function, switch-off memory, colour change, set individual colours
- Receivers communicate with each other and extend the reception range
- The channels can be switched individually or grouped.

Installation: outdoors in shafts of all kinds with appropriate humidity. The control box must be positioned in the upper area of the shaft for good radio reception.

Technical specification:

Power supply	230 V AC, 2 m power cable with plug	
	separate power supply unit and RGBW LED control for each channel	
	one luminaire can be connected per channel	
Degree of protection	IP54 (splash-proof)	
Dimensions	1-channel:	171 x 146 x 55 mm
	2-channel:	222 x 171 x 55 mm
	3 or 4-channel:	265 x 210 x 95 mm



CONTROL BOX FOR MAXISPOT/ SUPERSPOT	
1-channel, power supply unit 12 VDC / 0.35 A	20.231050
2-channel, power supply unit 12 VDC / 0.35 A	20.231051
3-channel, power supply unit 12 VDC / 0.35 A	20.231052
4-channel, power supply unit 12 VDC / 0.35 A	20.231053
CONTROL BOX FOR MEGASPOT/ COSMOSPOT/HONEYCOMB SPOT	
1-channel, power supply unit 12 VDC / 0.4 A	20.231060
2-channel, power supply unit 12 VDC / 0.4 A	20.231061
3-channel, power supply unit 12 VDC / 0.4 A	20.231062
4-channel, power supply unit 12 VDC / 0.4 A	20.231063
CONTROL BOX FOR DIFFERENT LUMINAIRE COMBINATIONS	
Universal box 1-4 channel	20.231070

2.4GHZ REMOTE CONTROLS / WALL SWITCHES

Handheld transmitter and wall switch for switching monochrome, RGB and RGBW luminaires
Suitable for universal LED control and all RGBW control boxes



4-channel handheld transmitter, mono



1-channel wall transmitter, mono



4-channel wall transmitter, mono



1-channel wall transmitter RGBW



8-channel wall transmitter RGBW

MONOCHROME	
4-channel handheld transmitter mono, including wall bracket and battery	20.231100
1-channel wall transmitter, mono, battery included	20.231101
4-channel wall transmitter, mono, battery operated	20.231102
4-channel wall transmitter, mono, connection to 230V	20.231103

RGBW	
1-channel wall transmitter RGBW, battery operated	20.231110
8-channel wall transmitter RGBW, battery operated or connection to 230V	20.231111
Power supply unit 230V-3.3V for 8 zones wall transmitter RGBW	20.231112

A data sheet with detailed lighting data for each product is available to download from our website.
Subject to change without notice! Please observe the safety regulations and our terms and conditions!

CONTROLS

2.4GHZ GATEWAY

With the 2.4GHz gateway, the RGBW control boxes can be controlled via a smartphone/tablet.

- Enables app-based operation of the RGBW control boxes
- Control by voice command with Amazon Alexa Skill or Google Assistant
- Integration into your own WLAN
- Timer function, dimmer, RGB or RGBW adjustable in the app

Installation: to ensure good reception, it is recommended to place the 2.4GHz gateway as close as possible to the receivers. The 2.4GHz gateway must be installed in a dry location.



Technical specification:

Power supply	5 V DC (included)
Degree of protection	IP20
Dimensions	91 x 66 x 15 mm

2.4GHz GATEWAY	
2.4GHz Gateway including plug-in power supply unit	20.231010

ON/OFF / DIMMING / RGB / RGBW

The universal LED control unit is used for switching on/off, dimming or controlling monochrome/RGBW luminaires with constant voltage 12/24 V DC (PWM clocked).

- Operation via app, handheld or wall transmitter
- Control by voice command with Amazon Alexa Skill or Google Assistant
- Integration into your own WLAN
- Timer function, switch-off memory
- Receivers communicate with each other and extend the reception range
- Only for the following RGB luminaires: Linear Line Micro, Linear Line Opal, Waveline and Waveline EDGE

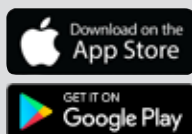

Installation: outdoors in shafts of all kinds with appropriate humidity. The universal LED control unit must be positioned in the upper area of the shaft for good radio reception.



Technical specification:

Power supply	12/24 V DC
Possible outputs	5
Output	60 W per output, max 150 W (12 VDC) 120 W per output, max 300 W (24 VDC)
Degree of protection	IP54 (splash-proof)
Dimensions	240 x 70 x 50 mm

2.4GHz CONTROL UNIT	
Universal LED control unit, 1-channel	20.231000



1-channel handheld transmitter, mono/RGBW



4-channel handheld transmitter, mono/RGBW



8-channel handheld transmitter, mono/RGBW



4-channel wall transmitter mono/RGBW

Technical specification:

Battery	2 x AAA
Power supply	230 Volt AC (only 4-channel mono, 4-channel mono/RGBW and 8-channel RGBW wall switches) (May only be installed by a trained electrician)
Degree of protection	IP20

MONOCHROME/RGBW	
1-channel handheld transmitter, mono/RGBW, battery included	20.231120
4-channel handheld transmitter mono/RGBW, incl. wall bracket & battery	20.231121
8-channel handheld transmitter mono/RGBW, incl. wall bracket & battery	20.231122
4-channel wall transmitter, mono/RGBW, battery operated	20.231123
4-channel wall transmitter, mono/RGBW, connection to 230V	20.231124

LUMINAIRE HOLDERS



Luminaire holder with joint, with retaining ring

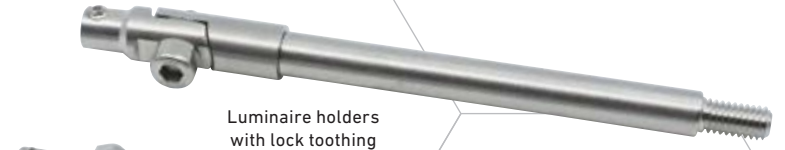

Luminaire holders with joint with lock tothing



Luminaire holder with joint, without retaining ring

Stainless steel



SDL-Black



Retro Bronze

Material: stainless steel V2A, stainless steel V4A

Installation: mounting options include base plate, brass dowel or ground spike

These luminaire holders allow all lights to be positioned above or below water with millimetre precision.

LUMINAIRE HOLDERS			V2A stainless steel	SDL-Black	Retro Bronze	V4A stainless steel
with joint and retaining ring Spotlight, Flat Light, Tube Light	short	30 mm	20.131001	-	-	-
	medium	105 mm	20.131002	-	-	-
	long	295 mm	20.131003	-	-	-
with joint, without retaining ring Ultraspot, Maxispot, Megaspot	short	40 mm	20.131011	20.831011	20.931011	20.351011
	medium	115 mm	20.131012	20.831012	20.931012	20.351012
	long	300 mm	20.131013	20.831013	20.931013	20.351013
	extra-long	600 mm	20.131014	-	-	-
joint with lock tothing Gigaspot	short	40 mm	20.131051	20.831051	20.931051	
	medium	115 mm	20.131052	20.831052	20.931052	
	long	300 mm	20.131053	20.831053	20.931053	-



Items supplied without luminaires

LUMINAIRE HOLDERS	
1 for plant pots with ground spike, without retaining ring	20.131030
2 for plant pots with stuffing box, without retaining ring	20.131031
3 with stuffing box, without retaining ring	20.131032

All luminaires can be mounted very easily and quickly in any plant container with this luminaire holder. Both axes are infinitely variable up to max. 290 mm.

For luminaire types: Ultraspot, Maxispot, Megaspot

A data sheet with detailed lighting data for each product is available to download from our website. Subject to change without notice! Please observe the safety regulations and our terms and conditions!

BASE PLATE, DOWEL

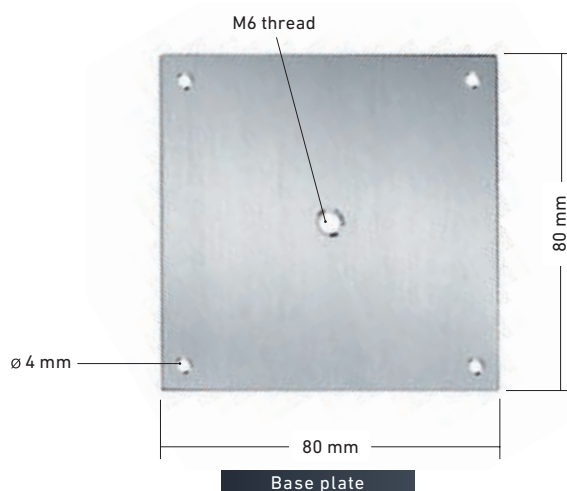

Base plate

All luminaire holders can be screwed onto this base plate.

Material: stainless steel V2A, stainless steel V4A

BASE PLATE	V2A stainless steel	SDL-Black	Retro Bronze	V4A stainless steel
80 x 80 mm	20.132000	20.832000	20.932000	20.352000

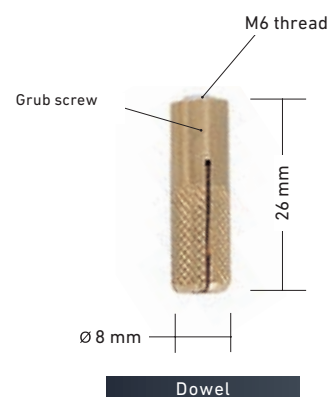

Dowel

All luminaire holders can be screwed onto this dowel.

Material: brass (stainless)

DOWEL	
M6	20.194000

GROUND SPIKE

Material: stainless steel V2A, coated black

Area of use: everywhere in the ground, gravel, etc., above or under water

- All luminaire holders can be screwed onto the 230 mm ground spike
- Height range for continuously adjustable luminaire holder: 65 mm – 275 mm

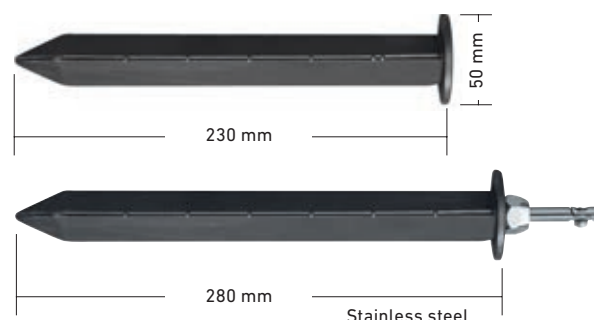

GROUND SPIKES	Suitable for	Stainless steel	SDL-Black	Retro Bronze
230 mm, without luminaire holder (not height-adjustable)	all luminaires	20.189000	-	-
280 mm with long luminaire holder, (freely adjustable, 65 – 275 mm)	Ultraspot, Maxispot, Megaspot	20.189002	20.889002	20.989002
280 mm with extra-long luminaire holder, (freely adjustable, 365 – 575 mm)		20.189006	-	-
280 mm with long luminaire holder and retaining ring (freely adjustable, 65 – 275 mm)	Spotlight, Flat Light, Tube Light	20.189003	-	-
280 mm with extra-long luminaire holder and retaining ring (freely adjustable, 365 – 575 mm)		20.189005	-	-
280 mm with long luminaire holder, joint with lock toothing (freely adjustable, 65 – 275 mm)	Gigaspot	20.189004	20.889004	20.989004

LINEAR LINE MICRO MOUNTING ADAPTER

With this mounting adapter and one of the three luminaire holders (with base plate or dowel) or the ground spike, the luminaire housing can be adjusted and positioned stably on the wall/ceiling or floor. The height (only with ground spike) and the inclination can be freely adjusted.



Mounting adapter

MOUNTING ADAPTER FOR LINEAR LINE MICRO	
Mounting adapter for Linear Line Micro (order luminaire holder separately)	20.131040

FROSTED GLASS, COLOUR & WARM-LIGHT FILTERS

WARM-LIGHT FILTER	
for Spotlight, Ultraspot and Superspot Mini	20.509050
for Flat Light	20.509060
for Maxispot and Superspot	20.509051
for Megaspot, Cosmospot and Honeycomb Spot	20.509053
for Gigaspot	20.509062

COLOUR FILTERS	
green for Maxispot and Superspot	20.509040
blue for Maxispot and Superspot	20.509041
red for Maxispot and Superspot	20.509042
yellow for Maxispot and Superspot	20.509043



Megaspot with warm-light filter



Maxispot with frosted glass

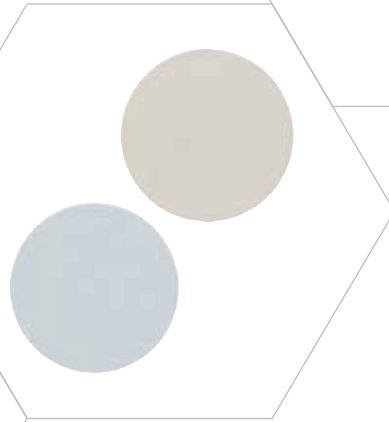

- For warm and soft light colours
- Especially suitable for mediterranean gardens
- Info: approx. 10% lower light intensity

FROSTED GLASS	
for Spotlight, Ultraspot and Superspot Mini	20.509059
for Maxispot and Superspot	20.509055
for Megaspot, Cosmospot and Honeycomb Spot	20.509056
for Gigaspot	20.509063

A data sheet with detailed lighting data for each product is available to download from our website. Subject to change without notice! Please observe the safety regulations and our terms and conditions!

HONEYCOMB ANTI-GLARE LOUVRE

The honeycomb anti-glare louvres listed here can be used to make all spotlights largely glare-free. The honeycomb anti-glare louvre is mounted in front of the light inside the luminaire. This honeycomb anti-glare louvre must be installed when the luminaire is manufactured.

Info: approx. 20% lower light intensity

HONEYCOMB ANTI-GLARE LOUVRE	
for Ultraspot and Superspot Mini	20.130965
for Maxispot and Superspot	20.130970
for Megaspot and Cosmospot	20.130980
for Honeycomb Spot	20.130990
for Gigaspot	20.130985



TUBULAR GLARE GUARD



The products listed here can be used to make all floodlights and spotlights largely glare-free. These glare guards can also be easily retrofitted to the luminaire housing.

Material: stainless steel V2A (except for the tubular glare guard for Spotlight: nickel-plated brass)

TUBULAR GLARE GUARD	Stainless steel	SDL-Black	Retro Bronze
for Spotlight, screw connection	20.130930	-	-
for Ultraspot, clamp-on design	20.130810	20.830810	20.930810
for Maxispot, clamp-on design	20.130811	20.830811	20.930811
for Megaspot, clamp-on design	20.130812	20.830812	20.930812
for Gigaspot, clamp-on design	20.130813	20.830813	20.930813

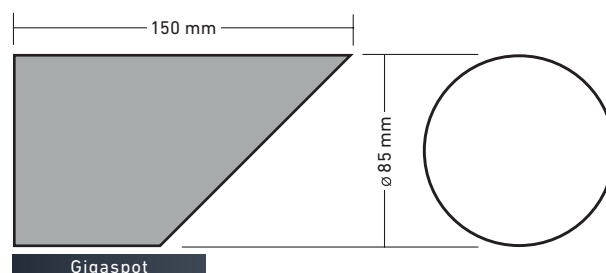
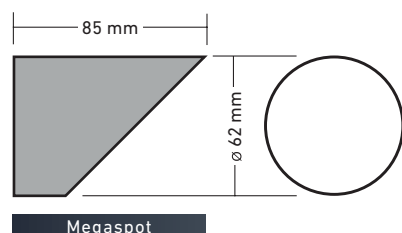
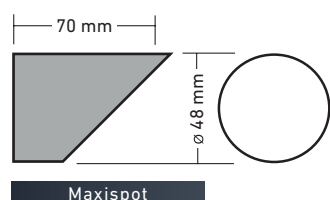
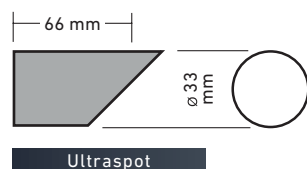
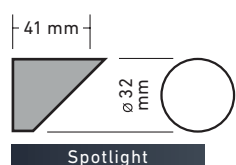

ASSEMBLY SLEEVE

Material: V2A stainless steel

Installation: to be bonded

Luminaire mounting: the luminaire can be "clicked in" quickly and easily.

ASSEMBLY SLEEVE	
for Superspot Mini	20.168017
for Superspot Compact	20.168018



MOUNTING TUBE

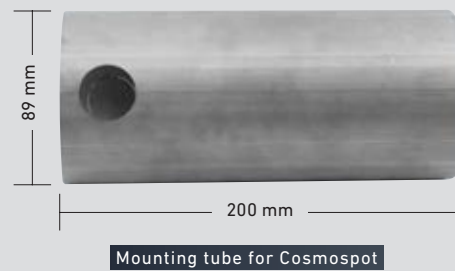
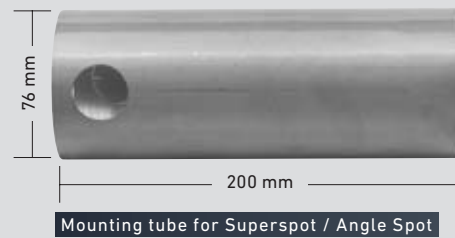
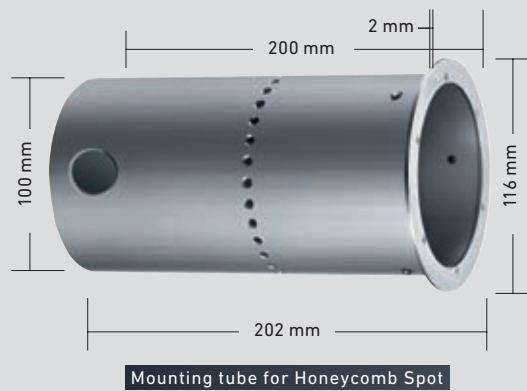

Material: stainless steel tube V2A, for Superspot, Angle Spot and Cosmospot, anodised aluminium tube with flange (snap lock) for Honeycomb Spot

Installation: For cementing in the ground
For installation in gravel or earth

MOUNTING TUBE	
for Superspot and Angle Spot	20.698048
for Cosmospot	20.698046
for Honeycomb Spot	20.698051

MOUNTING BOX

Material: V2A stainless steel

Installation: the mounting box is attached to the wooden formwork before concreting.

Dimensions: Ø 76 mm x 250 mm (Superspot / Angle Spot)
Ø 108 mm x 150 mm (Honeycomb Spot)

MOUNTING BOXES FOR FLOOR, WALL AND CEILING INSTALLATION	
Mounting box for Superspot and Angle Spot	20.168005
Mounting box for Honeycomb Spot	20.168008



Detailed lighting data is available in the technical data sheet for each product, which is available to download from our website. Subject to change without notice! Please observe the safety regulations and our terms and conditions!

MOUNTING BOXES

Material: stainless steel V2A (Superspot)
stainless steel V4A (Megaspot Pool)

Installation:

- Superspot For pond liner with pressure flange
- Megaspot Pool For metal and plastic pools with lock nut
For film-lined pools with pressure flange



Mounting box for Megaspot Pool, for plastic pools



Mounting box for Megaspot Pool, for film-lined pools



Mounting box for Superspot, for pond liner

MOUNTING BOXES FOR PONDS AND POOLS	
for Superspot with mounting holes, for pond liner	20.168013
Silicone flat sealing ring for Superspot mounting box	20.130913
for Megaspot Pool, for metal and plastic pools, includes lock nut and seal	20.168024
for Megaspot Pool, for film-lined pools, includes pressure flange	20.168025

GROUND TUBE, SQUARE



Ground tube, square

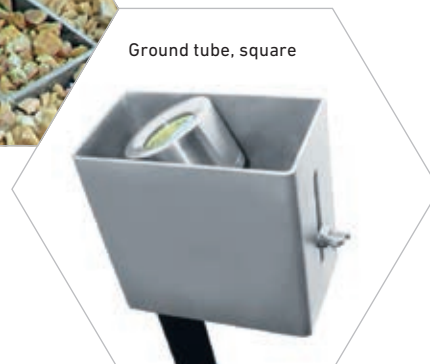

Dimensions:

- for Spotlight 80 x 35 x 100 mm
- for Maxispot/Ultraspot 120 x 55 x 100 mm
- for Megaspot 130 x 100 x 100 mm

Material: V2A stainless steel

Installation: for ground-level installation in gravel, earth or grass (interior can be left empty or filled with coarse gravel. Do not use earth!)

The ground spike 230 mm is recommended

Set includes: ground tube and short luminaire holder, does not include ground spike and luminaire

GROUND TUBE, SQUARE	
for Spotlight, includes short luminaire holder	20.168030
for Ultra and Maxispot, includes short luminaire holder	20.168031
for Megaspot, includes short luminaire holder	20.168032
Optional: ground spike 230 mm	20.189000

GROUND ANCHOR

Material: V2A stainless steel

Installation:

- for cementing in the ground
- The luminaires are attached to the ground anchor with 3 x M6 screws

GROUND ANCHOR	
for Topspot, Tube Light LED	20.189100



Ground anchor for Topspot



Ground anchor for Tube Light

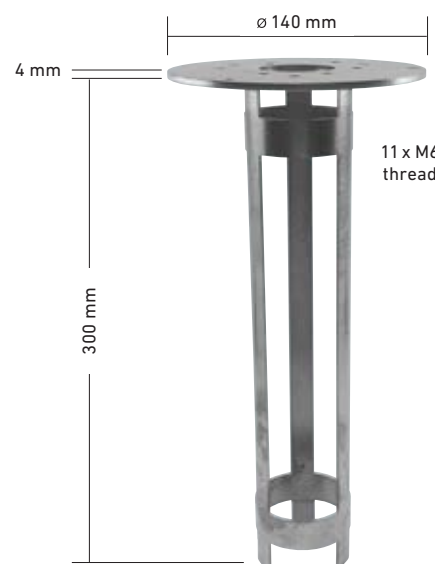

Ground anchor

GROUND INSTALLATION BOX



- Very robust and versatile housing with cover
- For all transformers, power supply units and cable connections
- Very quick and easy to install
- Cannot be driven on

Material: polypropylene (PP), light grey

Montage: Everywhere in the ground

Attention: for outdoor use, water drainage holes must be drilled in the bottom of the housing.

GROUND INSTALLATION BOX			
	Outer dimensions	Inner dimensions	
small	200 mm x 200 mm x 200 mm	150 mm x 150 mm x 160 mm	20.220040
medium	300 mm x 300 mm x 310 mm	240 mm x 240 mm x 265 mm	20.220041
large	400 mm x 400 mm x 360 mm	340 mm x 340 mm x 290 mm	20.220042

CABLE GLAND

- Cable gland for watertight routing of all power cables
- with O-ring and locknut
- Protection class IP68

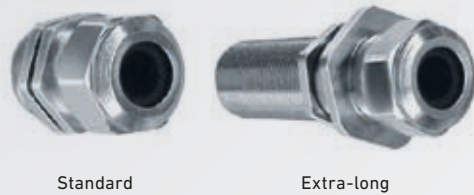

CABLE GLAND		
Version	Standard	Extra-long
Pool wall thickness	1 – 7 mm	10 – 45 mm
Drill hole	Ø 16 mm	
Thread type	M16 x 1.5	
Material	Nickel-plated brass	
Cable diameter	Ø 6 – 10.5 mm	
Art. No.	20.509024	20.509023

LUMINAIRE AND CONNECTION CABLES

- High-quality rubber cable
- Suitable for outdoor use

LUMINAIRE AND CONNECTION CABLES		
Cable (2 x 1 mm ²), per metre	Ø 6.8 mm	20.220030
Cable (2 x 1.5 mm ²), per metre	Ø 9.3 mm	20.220031
Cable (2 x 2.5 mm ²), per metre	Ø 10 mm	20.220032
RGB cable (4 x 1.5 mm ²), per metre	Ø 7.5 mm	20.220038
RGBW cable (6 x 1.5 mm ²), per metre	Ø 9 mm	20.220034

MARTENS PROTECTION BRAID

On request, martens protection can be ordered for the entire length of the cables in our luminaire sets. The luminaire cables must be inserted directly into the electric tube at the point where the martens protection braid ends.

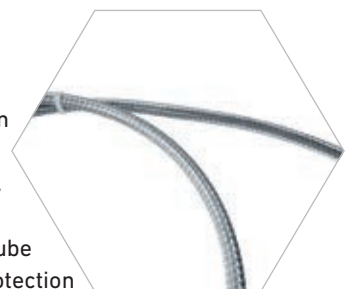

We cannot guarantee that the martens protection or the luminaire cables will remain undamaged.

Material: highly flexible stainless steel mesh V2A

MARTENS PROTECTION BRAID	
for 1 mm ² cable, per metre	20.509012
for 1.5 mm ² cable, per metre	20.509020

A data sheet with detailed lighting data for each product is available to download from our website. Subject to change without notice! Please observe the safety regulations and our terms and conditions!

INSTALLATION MATERIALS

INSTALLATION TOOL

Installation wrench set: all lights, except LED effect, can be securely screwed on or off with the corresponding mounting key.



Pin spanner

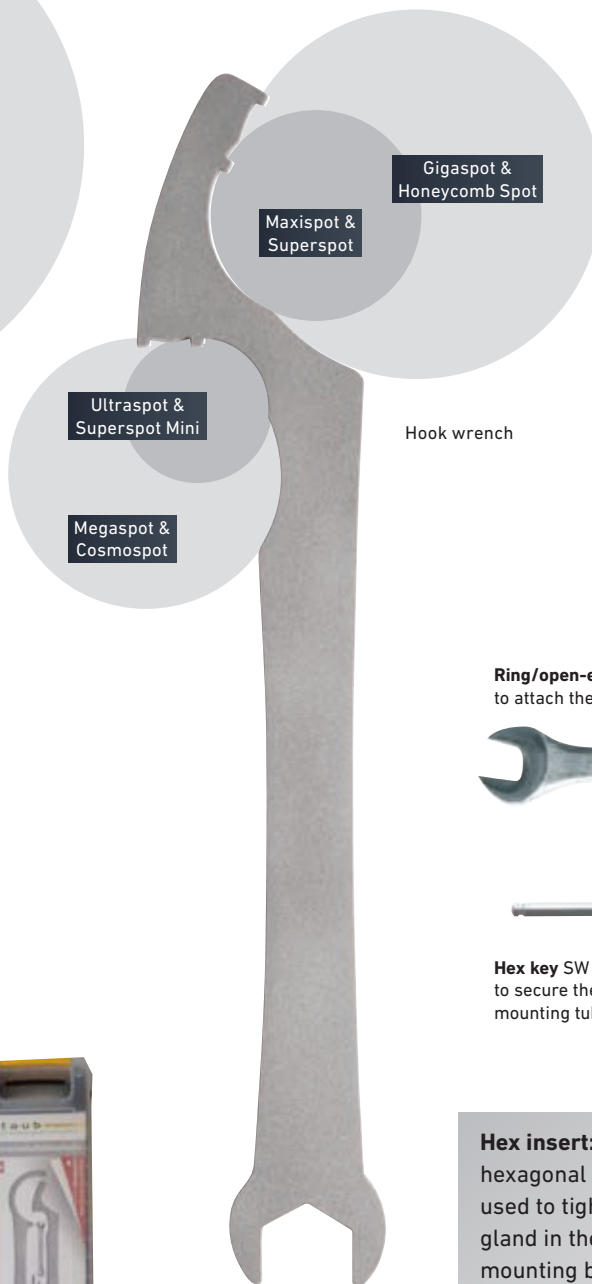

Hook wrench

Suitable for

- Ultraspot
- Maxispot
- Megaspot
- Gigaspot
- Angle Spot
- Superspot
- Cosmospot

Fixing pins
to support the luminaire against the light base



Fork wrench 19 mm for height adjustment of the luminaire holder in the ground spike

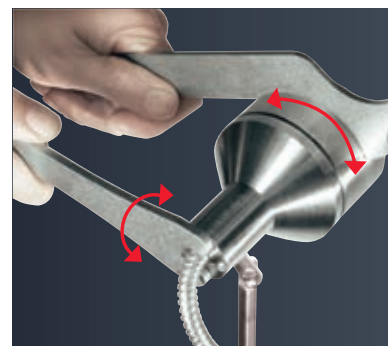

For fast and safe bulb replacement



For straightforward mounting of the luminaire holders

Ring/open-ended spanner 7 mm
to attach the luminaire to the luminaire holder



Hex key SW 2.5 mm
to secure the aluminium heat sink and mounting tube (Honeycomb Spot)



Hex insert: the slotted hexagonal insert can be used to tighten the cable gland in the Megaspot Pool mounting box.



INSTALLATION TOOL		
Installation key set (universal key)	suitable for all luminaires	20.220022
Hex insert No. 19 (3/8")	for Megaspot Pool mounting box	20.168026

WIRED CONNECTION

Area of use: this cable junction box allows 2 cables up to max. 1.5 mm² to be connected quickly and easily, 100% waterproof (IP 68). Thanks to the gel seal, the connection can be opened again later if necessary.

CABLE JUNCTION BOX (GEL)	
for two cables up to 2 x 1.5 mm ²	20.220018



Cable connection set and electrical box set

Express potting compound:
Curing time approx. 1 hour at 23°C
Curing time approx. 1.5 hours at 0°C



Area of use: for waterproof connection of 2 – 3 cables, above or under water.

CABLE CONNECTION SET	
for 1 cable connection Contents: ■ 1 x potting box small (32 x 27 x 35 mm) ■ 1 x potting box medium (41 x 35 x 35 mm) ■ 2 x cable clip, 3-way ■ 80 ml express potting compound (2 components) ■ Acetone (cable cleaning), cleaning material, protective gloves ■ Instructions for use	20.220020
for 2 cable connection Contents: ■ 2 x potting box small (32 x 27 x 35 mm) ■ 2 x potting box medium (41 x 35 x 35 mm) ■ 4 x cable clip, 3-way ■ 80 ml express potting compound (2 components) ■ Acetone (cable cleaning), cleaning material, protective gloves ■ Instructions for use	20.220013

Area of use: for waterproof connection of max. 7 cables (6 x luminaires), above or under water.

ELECTRICAL BOX SET	
for max. 6 luminaires Contents: ■ 1 x electrical box (80 x 80 x 52 mm) ■ 4 x cable clip, 5-way ■ 180 ml express potting compound (2 components) ■ Acetone (cable cleaning), cleaning material, protective gloves ■ Instructions for use	20.220019
large, for max. 4 luminaires with 6-wire cable Contents: ■ 1 x electrical box (93 x 93 x 52 mm) ■ 6 x cable clip, 5-way ■ 286 ml express potting compound (2 components) ■ Acetone (cable cleaning), cleaning material, protective gloves ■ Instructions for use	20.220091

Detailed technical data and safety data sheets for our products are available to download from our website.
Subject to change without notice! Please observe the safety regulations and our terms and conditions!

ADHESIVES & SEALANTS



ADHESIVES AND SEALANTS	
Adheseal black, 50 ml tube	20.220051
Versabond black, 310 ml cartridge, for film-lined pools	20.220054

Adheseal

Adheseal is a unique, particularly high-quality, permanently elastic MS polymer-based adhesive sealant that can be painted over (wet on wet). Adheseal offers perfect adhesion even on delicate materials.

- Very good UV resistance and thermal stability (-40°C to +100°C)
- Also suitable for bonding operations on damp substrates or under water
- Perfect adhesion even on delicate materials such as metal, plastic, rubber, (Plexiglass) glass, natural stone, galvanised materials, mirrors and much more ...
- Forms a skin within a very short time, dries quickly, hardens completely even with closed adhesions

Versabond

Versabond is a unique, permanently elastic assembly sealant based on the latest SPUR polymer technology. Versabond is ideal for an unlimited number of bonding and sealing operations on almost any surface.

- Permanently elastic – high flexibility!
- Excellent adhesion!
- Waterproof, even seals under water!
- Thermally stable from -35°C to +90°C!
- Long processing window! (approx. 1 hour)!
- Removable, ideal for reworking or repair work

CLEANING AND CARE SET



With these highly effective cleaning and care products, all stainless steel surfaces (luminaire housings, shades, etc.) can be purged of all environmental influences and permanently protected.

Contents:

- 1 stainless steel rust remover
- 1 stainless steel care product
- 1 sponge with Scotch-Brite
- Gloves
- Instructions for use

CLEANING AND CARE SET	
Cleaning and care set	20.220060

SETTING A SHINING EXAMPLE.

staub designlight combines perfect design with perfect quality. Our experience speaks for itself.

"staub designlight is an innovative and creative company that produces precise luminaires – just the way I need them!"

Ensuring high quality, from the initial consultation to the luminaires themselves, is my top priority in all my projects."

Jan Hauser
Designer / Owner
Outdoor decorator
Jan Hauser AG



"The convincing high quality and support we receive from staub designlight provides exactly what we need for our customers."

Ralph Hoffmann
Owner
Gartencenter Hoffmann AG



"I use staub designlight luminaires first and foremost because they are reliable in terms of their functionality, i.e. they are watertight. Good service and availability of spare parts, and a seven-year warranty. Short delivery times and good availability of the lights we use the most. With a competent team pulling the strings."

Sepp Hager
Managing Director
LUCE Elektro AG

"We attach great importance to high-quality solutions, both in the planning and implementation of our gardens.

Which is why we only use products that meet our high standards in terms of design and functionality."

Brian Wiss
Certified master gardener
Berger Gartenbau



SPARE PARTS

HP-LED MODULES, COMPLETE

In these HP-LED modules the dimmable, temperature-controlled electronics as well as the HP-LED and the lens are integrated in an aluminium housing. If the ambient temperature is too high, the integrated electronics inside the module freely regulate the power – so there are no more defective LEDs due to overheating.



HP-LED 3 W
Maxispot/Superspot



HP-LED 3 W
Angle Spot



HP-LED 9 W
Megaspot/Cosmospot



HP-LED 9 W
Honeycomb Spot

Advantages of HP-LED technology:

- Very high durability
- No more hot lights
- Very low power consumption
- Maintenance-free

Standard version

Voltage:	12 V AC/DC
Light colour:	The standard light colour is warm white (2700 K). All HP-LED modules are also available as special designs in warm white (3000 K) and cold white (6200 K).
Dimmable:	With DC power supply unit; DALI and PWM IMPORTANT: in AC mode the HP-LED modules are not dimmable.
Warranty:	5 years

LED MODULE
replaceable



MODULE FOR MAXISPOT AND SUPERSPOT, 12 V AC/DC	
3 W, lens 16°, warm white (2700 K)	20.176100
3 W, lens 22°, warm white (2700 K)	20.176101
3 W, lens 36°, warm white (2700 K)	20.176102
3 W, lens 34° x 17° (elliptical), warm white (2700 K)	20.176110
MODULE FOR ANGLE SPOT, 12 V AC/DC	
3 W, warm white (2700 K)	20.176103
MODULE FOR MEGASPOT AND COSMOSPOT, 12 V AC/DC	
9 W, lens 14°, warm white (2700 K)	20.176104
9 W, lens 20°, warm white (2700 K)	20.176105
9 W, lens 40°, warm white (2700 K)	20.176106
MODULE FOR HONEYCOMB SPOT, 12 V AC/DC	
9 W, lens 14°, warm white (2700 K)	20.176107
9 W, lens 20°, warm white (2700 K)	20.176108
9 W, lens 40°, warm white (2700 K)	20.176109

HP-LED MODULES WITHOUT LENSES

MODULE FOR MAXISPOT AND SUPERSPOT, 12 V AC/DC	
3 W, warm white (2700 K)	20.176120
MODULE FOR MEGASPOT AND COSMOSPOT, 12 V AC/DC	
9 W, warm white (2700 K)	20.176121
MODULE FOR HONEYCOMB SPOT, 12 V AC/DC	
9 W, warm white (2700 K)	20.176122



Lens for Megaspot, Cosmospot and Honeycomb Spot

Lens for Maxispot and Superspot

LENSES FOR HP-LED MODULES

LENS FOR MAXISPOT AND SUPERSPOT	
Lens 16°	20.176130
Lens 22°	20.176131
Lens 36°	20.176132
Lens 34° x 17° (elliptical)	20.176133
LENS FOR MEGASPOT, COSMOSPOT AND HONEYCOMB SPOT	
Lens 14°	20.176134
Lens 20°	20.176135
Lens 40°	20.176136

A data sheet with detailed lighting data for each product is available to download from our website. Subject to change without notice! Please observe the safety regulations and our terms and conditions!

REFLECTORS FOR GIGASPOT AND HONEYCOMB SPOT SUPER

REFLECTOR FOR GIGASPOT	
Reflector 27°	20.177000
Reflector 35°	20.177001
Reflector 53°	20.177002
REFLECTOR FOR HONEYCOMB SPOT SUPER	
Reflector 20°	20.177010
Reflector 30°	20.177011
Reflector 40°	20.177012
Reflector 80°	20.177013



LED BULBS

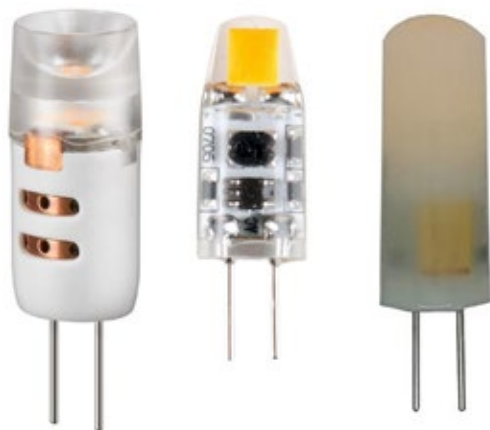
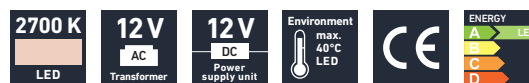

Standard version

Voltage:	12 V AC/DC
Light colour:	warm white (2700 K)
Dimmable:	Yes Light bulb No Spotlight, Flat Light, Tube Light
Warranty:	2 years

LED BULBS	
for Spotlight, G4, 1.2 W, warm white (2700 K), 90 lm	20.176200
for Glass Flask, G4, 1 W, warm white (2700 K), 100 lm	20.176201
for Flat Light and Tube Light, G4, 2 W, warm white (2700 K), 200 lm	20.176202

SEALING RINGS

To ensure continued tightness, the sealing ring must always be replaced when changing the bulb.



SEALING RINGS (O-RINGS)	
for Spotlight, light bulb, Flat Light, Tube Light	20.139900
for Ultraspot and Superspot Mini	20.139908
for Maxispot, Superspot and Angle Spot	20.139902
for Megaspot and Cosmospot	20.139906
for Gigaspot	20.139909
for Honeycomb Spot	20.139907

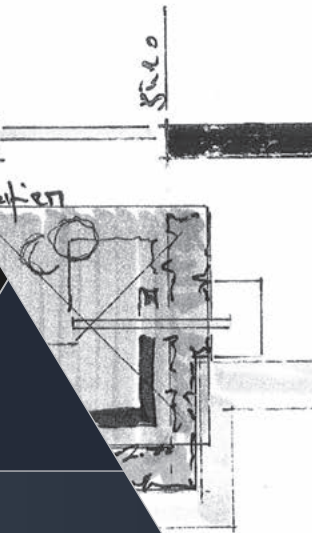
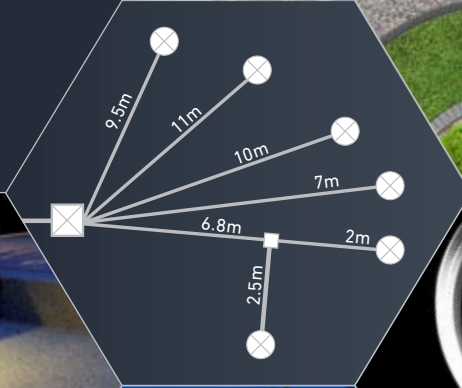



SERVICE AND PLANNING

Consultation | Planning | Sales

Marketing

Sample luminaires

P. 124 / 125

P. 126 / 127

P. 128 / 129

Demo case

Safety regulations

Terms and conditions

P. 130 – 133

P. 134 / 135

P. 136 / 137

WELL PLANNED, WELL ADVISED



Our services are focused entirely on fulfilling your individual requirements. We develop our innovative quality products with precisely this in mind – no challenge is too great for us! We offer true lighting perfection based on consistently high Swiss quality. We guarantee it doesn't get any better than this!

Our motivated team of qualified employees also ensures absolutely perfect results when it comes to planning and service. Our goal is the complete satisfaction of planners, resellers and end customers alike. Our innovations constantly set new standards in the market – our products and services will convince and inspire you!

Tel. +41 (0) 41 619 20 30
www.staub-designlight.ch

A data sheet with detailed lighting data for each product is available to download from our website.
Subject to change without notice! Please observe the safety regulations and our terms and conditions!

EXAMPLES FOR QUOTATION REQUESTS

Do you already have something specific in mind? Send us your hand-drawn sketch (based on the examples below) of your customised fairy lights or star set:

Pre-assembled,
ready for
installation
**LUMINAIRE
SETS**

FAIRY LIGHTS SET:

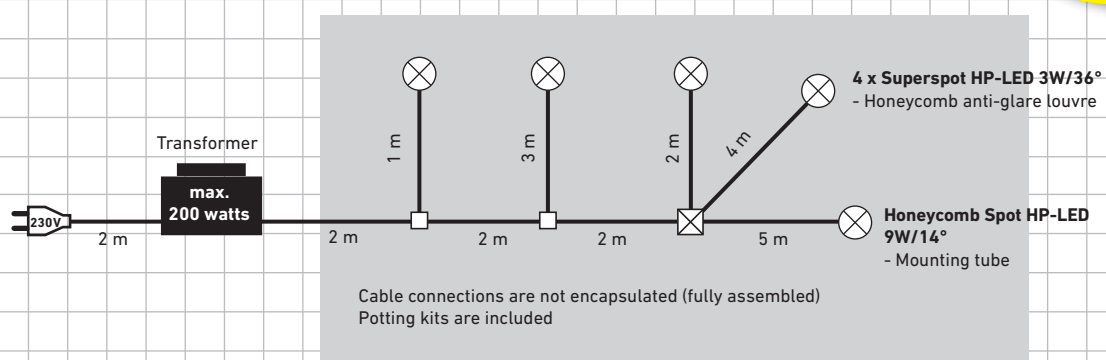

STAR SET:

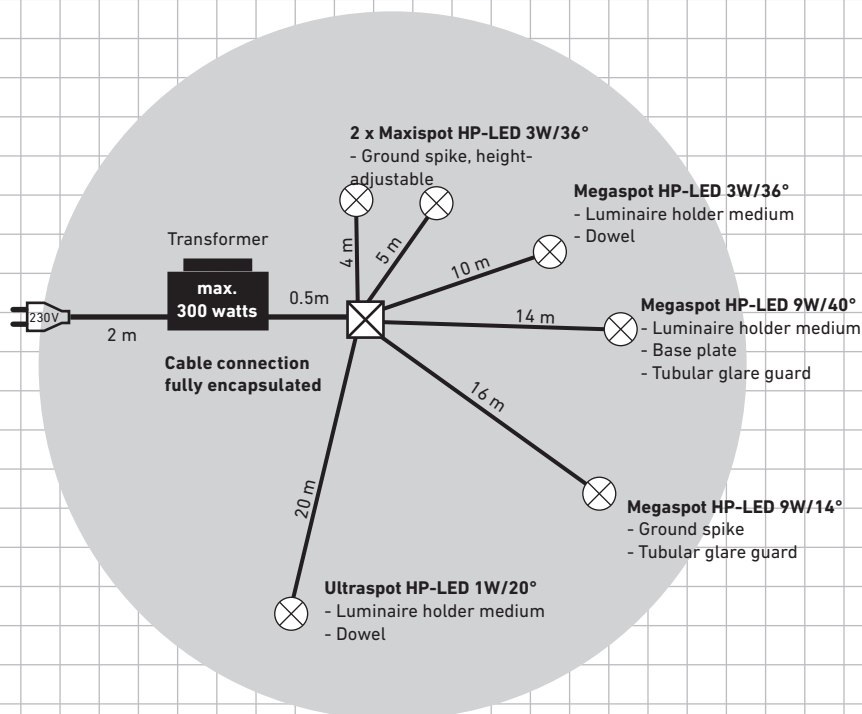

= cable connection for max. 3 cables

= Electrical box for max. 6 cables

= Luminaire

Note:

To prevent damage, we recommend laying the luminaire cables inside protective conduits.

STAUB DESIGNLIGHT = PERFECTION. AND THAT INCLUDES OUR TEAMWORK.

We provide comprehensive sales support and advice for the staub designlight products. Take advantage of our range of sales-promoting initiatives!

■ Planning a promotional campaign?

Are you planning a marketing campaign, a promotional mailing or a company exhibition? We will gladly support you with our promotional materials!

■ Do you need print media?

Contact us and tell us what you need – we will be happy to help out with all marketing queries!

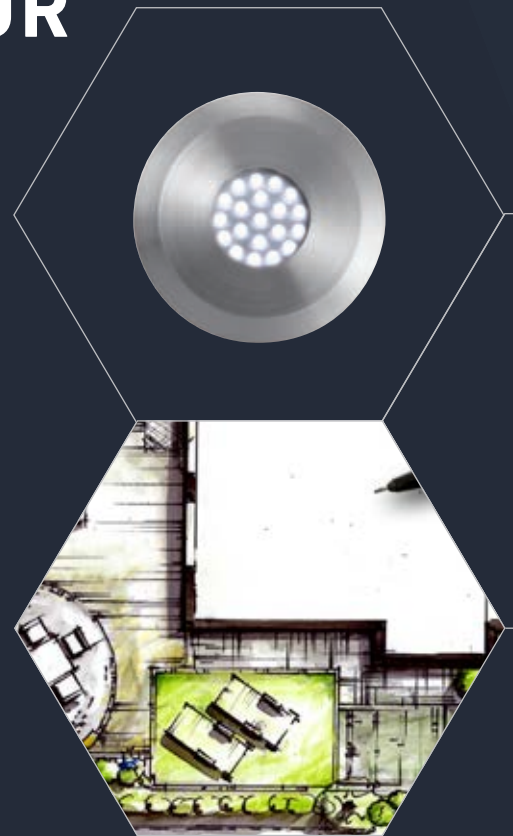

Let us advise you in person:
Tel. +41 (0) 41 619 20 30

■ Become our expert partner!

Our demo cases allow you to give expert advice directly to your customers. In addition, we pass your contact details to any prospective end customers in your area who contact us directly, thus actively supporting your sales of our high-quality products!



■ The Staub Designlight Professional Workshop

Want to get some hands-on experience with our products to help boost your sales? Simply contact us to arrange a workshop for you and your staff!

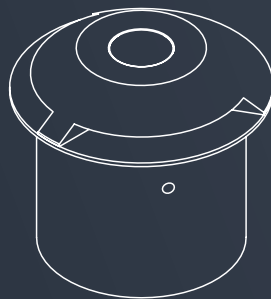

■ On-site consultation

If required, we would be delighted to support you in person at your customer's premises – with an abundance of lighting ideas and extensive know-how!



Do you need more catalogue copies?
You can request these from us free of charge:

E-mail: info@staub-designlight.ch





EXEMPLARY SERVICE AT ALL TIMES

Test our luminaires! Whether spotlights, recessed or surface-mounted luminaires – we provide you with every product you need, including the required accessories. This is the ideal opportunity to test all the available options and effects.

Find the
optimal luminaire:
**DISCOVER OUR
SAMPLE CASES!**

SPOTLIGHT CASE

BASIC EQUIPMENT FOR SURFACE-MOUNTED LUMINAIRES

Contents that inspire and
GENERATE SALES!



1

2 Microspot Demo Set

An ideal addition to your order: 3 microspots in a set – perfect for your demo.



1

1 SPOTLIGHT CASE	
Basic equipment for surface-mounted luminaires, 18-piece set	20.150007
2 MICROSPOT DEMO SET	
Microspot round, Microspot Quadro, Microspot 30°	20.150015

SAMPLE CASES

TAILORED TO YOUR REQUIREMENTS



SAMPLE CASES	
Tailored to your requirements	20.150300

DEMO CASE: PROFESSIONAL DLP



DEMO CASE: PROFESSIONAL DLP

34-piece set, blank cover

20.150004

DEMO CASE: PROFESSIONAL DLP+

ALL-INCLUSIVE PACKAGE



Ideally
equipped for
**MAXIMUM
SALES
SUCCESS!**

DEMO CASE: PROFESSIONAL DLP +	
44 pieces, fully equipped	20.150006

SAFETY REGULATIONS

1. All **staub designlight** luminaires may only be operated with the corresponding required power/voltage.
2. Before using a **staub designlight** luminaire with a screw attachment for the first time, make sure that the front part of the light is screwed tightly in place. Use the universal mounting key (see accessories). Otherwise, the water-resistance of the luminaire is not guaranteed.
3. Always switch off the power supply before opening a luminaire. If the luminaire is wet, dry the light housing thoroughly.
4. Regarding halogen lights: never pour water over hot halogen lights. The light glass may be destroyed due to the rapid change in temperature. Never touch a halogen light that is switched on or has not yet cooled down – danger of burns! When using a **staub designlight** halogen luminaire above water, a safety distance of at least 20 cm from flammable or heat-sensitive materials must be ensured on all sides, as the temperature of the luminaire housing can exceed 150°C. In flammable floors, walls, ceilings, etc. (wood, plastic, etc.) only LED lights may be installed.
5. Only use the halogen bulbs specified by **staub designlight ag**. Unsuitable bulbs may destroy the luminaire by generating too much heat. Replace the sealing ring (O-ring) every time you replace the bulb. It is essential that you follow the corresponding operating instructions.
6. All **staub designlight** luminaires can be used indoors and outdoors, above or under water. The corresponding restrictions are listed on the relevant catalogue pages. All **staub designlight** luminaires that are operated via a plug-in power supply unit may only be used indoors.
7. The **staub designlight** spotlight, flat light, tube light as well as the Ultraspot, Maxispot, Megaspot and Gigaspot, which are not operated under water, must be mounted on the corresponding luminaire holders to ensure adequate cooling! All lights must not be covered with insulating materials such as plastic, fabric, paper, etc. Fire hazard! The ambient temperature must not exceed 40°C.
8. The iron-core and toroidal transformers (including connection cables) are designed for outdoor use. Iron-core transformers are waterproof against temporary immersion in accordance with IP 67 (mains plug with IP 20). However, they must not be placed in water. Toroidal transformers are only splash-proof in accordance with IP 54. The connection cables must be protected against martens. The connecting cable's power plug must be plugged into a water-protected socket which is protected by a residual current circuit breaker (RCD). If no mains plug is required, the mains connection (230 Volt AC) may only be established by a trained and qualified electrician. All transformers must be installed outside in a cement shaft or in the **staub designlight** ground installation box in the ground with sufficient fresh air supply (for cooling of the transformer/power supply unit). Regarding the IP 67 iron-core transformer, any water penetrating the shaft/box must be able to drain off immediately into the ground (drainage bed). The IP 54 toroidal transformer must not come into contact with running or standing water. All transformers must not be installed in inflammable housings or niches (e.g. made of wood). The local electrical installation regulations, especially VDE 0100, SEV NIN 1000-1, 1995, must be observed. The input and output circuits must be installed in accordance with local installation regulations and routed in electrical conduits for protection. All electrical cable connections must be grouted/sealed to ensure that they are watertight.
9. All electrical cables that are laid in the ground must be routed in electrical conduits for protection. All cables laid above ground in outdoor areas to which animals have access (e.g. martens) must be protected by means of a martens-resistant conduit.
10. All cable connections and electrical boxes must be professionally waterproofed.
11. Damaged **staub designlight** products must be repaired immediately via our customer service team, otherwise their water-resistance and operational safety cannot be guaranteed.
12. All **staub designlight** LED lights may only be operated up to a maximum ambient temperature of 40°C. The 230 V AC line network must not transmit any impermissible peak voltages (peak to peak) to the transformer/power supply unit, for example during thunderstorms. On the 12/24 V side, the DC voltage must not be exceeded (not even for a short time), otherwise the electronics and/or the LED may be destroyed.
13. All **staub designlight** luminaires may only be operated with an appropriate transformer/power supply unit and an upstream residual current circuit breaker (RCD). For safety reasons, the user must seek advice from an electrical specialist to determine whether an RCD is already installed in the building.
14. All electrical installations with operating currents above 2 A or operating voltages above 50 V AC or 120 V DC, which are newly created or modified, may only be implemented by a specialist with the appropriate installation permit.
15. All **staub designlight** luminaires that are used outdoors as underwater lights and are approved for this purpose by **staub designlight ag** must be removed from the water during the winter season, unless they are installed at a depth of at least 30 cm, because the glass spheres, glass bulbs and spotlight glass may be destroyed in extreme cold conditions (ice).
16. All **staub designlight** luminaires/accessories which are used under water must not come into contact with chlorine, hydrochloric acid or other aggressive additives, which may cause the surface of the stainless steel to oxidise or corrode. This does not apply to the "Poolstar HP-LED" and "Megaspot Pool HP-LED" underwater luminaires. These may be used in water containing the usual chlorine levels that are permitted in swimming pool areas. Other water additives (e.g. brine baths, etc.) must be tested to check the resistance of the stainless steel before use and approved in writing by **staub designlight ag**.



staub designlight ag offers no warranty and accepts no liability for damages caused by non-observance of these instructions!

WARRANTY CONDITIONS

staub designlight ag grants its customers the following warranty periods from the invoice date for all **staub designlight ag** products ordered after 1 January 2014: for all electronic control units: 2 years; for power supplies, HP-LED modules, Waveline, Waveline EDGE and Curveline: 5 years; for all other products: 7 years. For products delivered before 1 January 2014, the warranty periods that were valid at the time of invoicing shall apply. The warranty period for custom-made luminaires and contract work is one year from the invoice date.

The warranty covers the repair or replacement, free of charge, of all components that have become inoperable due to manufacturing or material defects. It does not cover mechanical damage (including to paintwork), glass breakage, light bulbs, LEDs, electronics, shipping costs, consequential damages as well as removal and installation costs at the installation site. **staub designlight ag** cannot provide a guarantee for the indicated service life of the bulbs and LEDs. This also applies to any changes in the light colours of bulbs, LEDs, glass elements and colour filters. Repairs or replacements do not extend the warranty period. Damage caused by incorrect or improper installation/use of the **staub designlight** products is also excluded from the warranty. In case of subsequent modifications to delivered **staub designlight** products or non-compliance with assembly and/or safety instructions by the reseller or end customer, the associated warranty/liability shall expire with immediate effect. The front part

of the light housing of the Poolstar HP-LED containing the integrated electronics and LEDs must not be opened by the reseller or end customer, otherwise the warranty/liability shall expire with immediate effect. Any additional restrictions are listed in the respective product data sheets/regulations. Should repairs be necessary, the purchaser of our products is obligated to send the corresponding product to **staub designlight ag** free of charge. **staub designlight ag** shall not cover all costs incurred in this context. **staub designlight ag** also does not carry out repairs or product exchanges at the installation location.

Martens protection: this is provided by means of a high-quality, flexible stainless steel hose or stainless steel mesh hose, which protects the luminaire cable from marten bites. **staub designlight ag** cannot guarantee that the luminaire cable or the stainless steel hose/stainless steel mesh hose will nevertheless be impervious to damage by martens or other animals.

Warranty claims: please return any products to us together with a copy of the invoice. Defective luminaires must always be returned together with the transformer, power supply unit and electronics (if installed externally). The removal and installation costs will not be covered by **staub designlight ag**.

CARE INSTRUCTIONS

All **staub designlight** luminaires and accessories are made from high-quality, predominantly V2A stainless steel (or V4A as special designs). In aggressive environments, e.g. with exposure to road salt in the winter, or with rust and other aggressive particles in the air, or with pond water containing chlorine or other strongly oxidising media, etc., it is possible that a light coating of rust particles (flash rust) may form on the surface of our products. Remedy: clean the affected parts with a plastic Scotch-Brite product (pan cleaner). Never use steel wool or brushes with metal wires to clean the stainless steel parts. After cleaning, rinse the components in fresh water and let them dry. Look after your **staub designlight** products with our cleaning and maintenance set. Doing so will ensure that our products stay protected against extreme environmental influences for a long time and also look like new.

PRODUCT AND TRADEMARK PROTECTION

Our **staub designlight** luminaires and accessories are internationally protected by law and may not be reproduced or copied for personal use without our express written permission. (Articles 6 and 8 of the Swiss federal law). This also applies to all photos and construction drawings of all **staub designlight** luminaires. Individual products are patented or patent pending in Switzerland. CH Patent No. 701 962, No. 174/13; German utility model DGM 20 2009 014 794.0 and 20. 2013 104 885.2

JANUARY 2020

GENERAL TERMS AND CONDITIONS

General Information

■ The subject of these General Terms and Conditions (GTCs) is the basic regulation of the business transactions between **staub designlight ag** and the contractual partner as well as the general determination of the parties' mutual rights and obligations. These GTCs thus form the framework for all legal transactions between **staub designlight ag** and the customer; in particular they form the exclusive basis for the performance of services, the production of works and the sale of products. The GTCs are binding for all present and future business transactions with **staub designlight ag** until they are replaced by a new version, even if they are not explicitly referred to in a later legal transaction. Only those terms and conditions which are currently listed online in German on the **staub designlight** website are legally valid. Other conditions of the customer are only valid if they have been expressly accepted by **staub designlight ag** in writing.

■ Each order is only deemed to be accepted following clarification of all details and explicit written confirmation by **staub designlight ag**. The order confirmation issued by **staub designlight ag** is decisive with regard to the order's scope and execution. Errors and technical changes are, however, reserved. Quotations which do not contain an acceptance period are not binding.

■ Unless otherwise agreed in writing, prices are EXW Stansstad (Incoterms 2020); excluding VAT, packaging, freight/postage and insurance. If the procurement costs increase in the course of order processing (price surcharges from suppliers, additional fiscal burdens, increases in customs duties, increases in transport costs, currency fluctuations of more than five per cent), we reserve the right to adjust the prices accordingly. In the event of a price increase in the course of order processing, the purchaser is entitled to withdraw from the order, unless said price increase is reversed at the purchaser's immediate written request. Our prices and these General Terms and Conditions are subject to change at any time.

■ Partial deliveries are permitted. The information provided by the supplier regarding the weight and dimensions of the goods and packaging is not binding.

■ **staub designlight ag** is entitled to make the acceptance and execution of orders dependent on a security or advance payment.

■ **staub designlight ag** shall bear no foreign currency risks. Therefore, exchange-rate fluctuations may trigger price adjustments.

Terms of payment

■ The invoices are payable within 20 days net (expiry date). Advance payment shall apply in case of deliveries abroad. Other agreements are only valid subject to written confirmation by **staub designlight ag** to the customer. In the event of late payment, all outstanding invoices shall become due. In the case of delayed payment (of delivered orders), orders which have already been confirmed by **staub designlight ag** for a specific payment date and which have not yet been delivered, may also be immediately converted to advance payment. **staub designlight ag** reserves the right to charge collection expenses and interest on arrears, as well as a reminder fee. Pending receipt of full payment, the delivered goods shall remain the property of **staub designlight ag**. **staub designlight ag** reserves the right at any time to make deliveries only against advance payment or cash on delivery. This also applies to deliveries that are already confirmed with an invoice and a different payment term.

■ The right to offset payment against any existing or asserted claims does not exist. The customer's payment obligation shall not be affected by any claims asserted for defects.

Reservation of title

■ **staub designlight ag** shall remain the owner of all of its delivered goods until it has received the contractual payments in full. The cus-

tomers shall cooperate with measures which are necessary to protect the property of **staub designlight ag**; in particular, upon conclusion of the contract, the customer hereby authorises **staub designlight ag**, at the customer's expense, to proceed with entering and reserving the retention of title in public registers, books or similar in accordance with the respective laws of the relevant country, and shall complete all formalities in this regard. The customer shall maintain the delivered items at its own expense during the period of retention of title and insure them for the benefit of **staub designlight ag** against theft, breakage, fire, water and other risks. Furthermore, it shall implement all measures necessary to ensure that the ownership claim of **staub designlight ag** is neither impaired nor cancelled.

Delivery times

■ The delivery period begins as soon as the contract has been concluded, all official formalities such as import, export, transit and payment permits have been obtained, the payments that are due when the order is placed and any securities have been provided and the essential technical issues have been resolved. The delivery deadline shall be deemed to have been met if the notification of readiness for dispatch has been sent to the customer before its expiry. The delivery deadline shall be extended by a reasonable period of time if the customer subsequently changes specifications and thus causes a delay in deliveries or services. In addition, no responsibility is accepted for delays caused by unforeseen events such as force majeure, mobilisation, war, riots, shortages of raw materials, breakdowns, factory rejects, strikes, transport delays or other events beyond our control. If, due to such events, the ordered goods can only be delivered late or not at all through no fault of **staub designlight ag**, the customer shall not be entitled to assert claims against **staub designlight ag**.

Drawings and documentation

■ **staub designlight ag** reserves sole ownership and copyright over all drawings, photos, drafts, cost estimates and other documents belonging to **staub designlight ag**. The copying and further use of catalogue material is prohibited by copyright. Such documents are personally entrusted to the customer and may not be made accessible to third parties or copied without the written consent of **staub designlight ag**. They shall be returned to **staub designlight ag** upon first request. For each violation of this provision, the customer shall pay a contractual penalty of CHF 20,000.

■ **staub designlight ag** reserves the right to claim further damages and is entitled to withdraw from the contract, whereby the customer shall not be entitled to assert claims for compensation.

Place of performance, shipping and transport risk

■ The place of performance is Stansstad. Use and risk shall pass to the customer as soon as the goods leave the warehouse of **staub designlight ag**; this also applies to free-domicile deliveries (CPT Incoterms 2020).

■ Transport insurance shall only be taken out at the express request of the customer and at the latter's expense. Shipments with possible transport damages shall be accepted and the defects reported immediately in writing to the respective transport company for the purpose of recording the facts (copy to **staub designlight ag**). Complaints and notices of defects must be received by **staub designlight ag** within eight days from arrival of the goods, otherwise the delivery shall be deemed accepted without reservation. Returns sent to **staub designlight ag** without sufficient postage shall not be accepted.

Warranty for defects

■ **staub designlight ag** provides a warranty for defects that are present at the time of delivery in accordance with the following

A data sheet with detailed lighting data for each product is available to download from our website.

Subject to change without notice! Please observe the safety regulations and our terms and conditions!

provisions. All obvious and/or recognised defects must be reported to **staub designlight ag** in writing and specified within eight days from receipt of the products, and in all cases before further processing/ installation. The nature of the warranty is at the discretion of **staub designlight ag**, and shall either take the form of elimination of the defect (rectification of defects) or replacement delivery for products that were reported as defective and returned. The transport, travel, labour and material costs are excluded, except for the costs of return delivery. Any liability for damages is also – as far as legally permissible – excluded.

Right of return

- Luminaire sets manufactured to customer specifications cannot be returned.

- Individual luminaires with customer-specific cable lengths can be returned within 20 days of the invoice date in exchange for a credit note, provided that they are in perfect condition and have not yet been installed. **staub designlight ag** reserves the right to charge a corresponding handling fee as well as a fee for the restoration of the luminaires to their original condition. Credit notes are not paid out in cash and can only be offset against invoices issued by **staub designlight ag**.

- Luminaires in their original condition and other standard stock products may be returned within 20 days of the invoice date in exchange for a credit note, provided that they are in perfect condition and have not yet been installed. **staub designlight ag** reserves the right to charge a corresponding handling fee. Credit notes are not paid out in cash and can only be offset against invoices issued by **staub designlight ag**.

Warranty conditions

- **staub designlight ag** grants its customers the following warranty periods from the invoice date for all **staub designlight ag** products ordered after 1 January 2014: for all electronic power supply and control units: 2 years; for HP-LED modules: 5 years; for all other products: 7 years. For products delivered before 1 January 2014, the warranty periods that were valid at the time of invoicing shall apply. The warranty period for custom-made luminaires and contract work is one year from the invoice date.

- The warranty covers the repair or replacement, free of charge, of all components that have become inoperable due to manufacturing or material defects. It does not cover mechanical damage (including to paintwork), glass breakage, light bulbs, LEDs, electronics, shipping costs, consequential damages as well as removal and installation costs at the installation site. **staub designlight ag** cannot provide a guarantee for the indicated service life of the bulbs and LEDs. This also applies to any changes in the light colours of bulbs, LEDs, glass elements and colour filters.

- Should repairs be necessary, the purchaser of our products must send the corresponding product to **staub designlight ag** free of charge. **staub designlight ag** shall not cover all costs incurred in this context. **staub designlight ag** also does not carry out repairs or product exchanges at the installation location. Repairs or free replacements do not extend the warranty period. Damage caused by incorrect or improper installation/use of the **staub designlight** products by the customer or third parties is also excluded from the warranty. Any additional restrictions are listed in the respective product data sheets/regulations.

- Martens protection: this is provided by means of a high-quality, flexible stainless steel hose, which protects the luminaire cable against martens bites. **staub designlight ag** cannot guarantee that the luminaire cable or the stainless steel hose will nevertheless be impervious to damage by martens or other martens.

- All our safety regulations and General Terms and Conditions are also included in these warranty conditions.

- In case of subsequent modifications to delivered **staub designlight** products or non-compliance with assembly and/or safety instructions by the reseller or end customer, the associated warranty/ liability shall expire with immediate effect. Any warranty claims must be sent to **staub designlight ag** with the copy of the invoice. Defective lights must always be returned together with the associated transformer or power supply unit as well as the LED electronics or the electrical control unit (if mounted externally).

Exclusion of further liability

- All cases of contractual infringement and their legal consequences, as well as all claims of the customer, on whatever legal grounds, are exclusively governed in these terms and conditions. In particular, unless explicitly specified, all claims for compensation, reduction, cancellation of or withdrawal from the contract are excluded. The customer is not entitled under any circumstances to claim compensation for damages other than those caused directly to the delivered item itself, such as production stoppages, loss of use, loss of orders, loss of profit, or other direct or indirect damages. This exclusion of liability does not apply to illegal intent or gross negligence on the part of **staub designlight ag**. However, it does also apply in the case of illegal intent or gross negligence on the part of auxiliary persons.

Product and trademark protection

- Our **staub designlight** luminaires and accessories are legally protected in Switzerland and abroad (in particular by patents) and may not be copied or reproduced for personal use without our express written permission. This also applies to all photos and design drawings of all **staub designlight** luminaires.

Severability Clause

- Should individual provisions of this contract be legally ineffective, or should there be a loophole in the contract, this shall not affect the validity of the remaining contractual content. The ineffective provisions shall be deemed to be effectively replaced by such provisions that best reflect the intentions of the contracting parties as expressed in the contract. Any contractual loopholes shall be filled in the same way.

Place of jurisdiction and applicable law

- The place of jurisdiction is the headquarters of **staub designlight ag**, currently 6362 Stansstad (Stans). However, the latter reserves the right to sue the customer at its place of business. The legal relationship between the parties is subject to Swiss substantive law (excluding the Vienna Sales Convention).

Issue of January 2020

IP 68-TESTED – 100% WATERPROOF!



IP protection classes in accordance with DIN EN 60529

1st code number		2nd code number Protection against water	Protection against water								
Angle of protection	Foreign object protection		no protection	Against vertically falling dripping water (Condensation)	Against water dripping at an angle (up to 15° deviation)	Against spray water (up to 60° deviation)	Protection against splashing water	Protection against hose water (jet)	Protection against powerful water jet	Protection against temporary immersion	Protection against prolonged submersion
			IP x0	IP x1	IP x2	IP x3	IP x4	IP x5	IP x6	IP x7	IP x8
no protection	no protection	IP 0x	IP 00								
Against extensive contact (with the back of the hand)	Against solid foreign bodies over 50 mm thick	IP 1x	IP 10	IP 11	IP 12						
Against finger contact	Against solid foreign bodies over 12.5 mm thick	IP 2x	IP 20	IP 21	IP 22	IP 23					
Against contact with tools, wires or similar over 2.5 mm thick	Against solid foreign bodies over 2.5 mm thick	IP 3x	IP 30	IP 31	IP 32	IP 33	IP 34				
Against contact with tools, wires or similar over 1 mm thick	Against solid foreign bodies over 1 mm thick	IP 4x	IP 40	IP 41	IP 42	IP 43	IP 44				
Complete protection against contact	Protection against dust in harmful quantities	IP 5x	IP 50				IP 54	IP 55			
Complete protection against contact	Complete protection against dust	IP 6x	IP 60					IP 65	IP 66	IP 67	IP 68

Our luminaires
staub designlight ag

KEY TO SYMBOLS



IP 20: This product has no moisture protection and may only be used in dry areas.

IP 54: This product is protected against splashing water from all sides. It must not be used under water.

IP 67: This product is protected against almost all environmental influences and temporary immersion in water. However, it must not be used under water.

IP 68: This product is 100% waterproof. It can be used anywhere above or below water.



V2A: This product is made of very high quality stainless steel. All luminaires/accessories which are used under water must not come into contact with chlorine, hydrochloric acid or other aggressive additives, as these may cause the surface of the stainless steel to oxidise or corrode.

V4A: This product is made of very high quality stainless steel and can be used in swimming pools with the usual chlorine additives. See also page 134, paragraph 16.



This product is made of opal acrylic glass.



The luminaire cable is protected against martens bites and mechanical stress by means of a high-quality, flexible stainless steel hose over a length of 40 cm from the light base.



This product features a 60-cm-long flexible gooseneck. This allows free positioning and alignment of the luminaire.



This product has a round front part as standard.



This product features a swivelling ball joint. This allows the light cone to be tilted by 40° and rotated by 360°.



This product features a honeycomb anti-glare louvre as standard.



This product features frosted glass as standard.

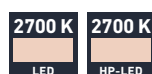

This product has the specified light colour in Kelvin.



• This product is operated by means of a transformer. Operating voltage: input 230 VAC/50Hz, output 12 VAC.

• This product is operated by means of a power supply unit. Operating voltage: input 230 VAC/50Hz, output 12 VDC or 24 VDC.

• Thanks to the IP 67 protection, the transformer or power supply unit can also be used outdoors (e.g. in shafts), but not under water.



This product can be infinitely dimmed in direct voltage (DC) mode with DALI or PWM, or can be infinitely controlled via the built-in potentiometer on the power supply unit.



The product requires a separate RGBW or RGB control unit. See page 106/107.



Temperature-monitored HP-LED control unit. If the ambient temperature is too high (higher than 40°C) or if heat accumulates in the luminaire, the built-in electronics freely regulate the luminous intensity to ensure that the LED integrated inside the module is not destroyed. The LED light must not be operated in ambient temperatures above 55° Celsius.



The LED version of this product may only be used up to a maximum ambient temperature of 40°C. At higher ambient temperatures, the life of the LED may be greatly reduced or the LED may be destroyed.



This product meets the basic safety requirements in accordance with all relevant European Directives.



The product meets the specified energy efficiency.



This product's LED module, LED unit and illuminant can all be changed.

LEGAL NOTICE

Publisher: staub designlight ag, unter Sagi 6, CH – 6362 Stansstad

Picture credits:

Abderhalden Gartenbau AG · www.abderhalden.ch	P. 45/95
Berger Gartenbau · www.berger-gartenbau.ch	P. 2/28/55/67/68/79/122
Bitters · www.gartenpartner-bitters.de	P. 19
EGLI Gartenbau AG · www.gartenbau-egli.ch	P. 8/25/35/68/90
Fautz die Gärten · www.fautz-diegaerten.de	P. 19/76/83/89/98
Forster Garten- und Landschaftsbau · www.forster-garten.de	P. 19/57/60/75
Gartencenter Hoffmann · www.gartencenter-hoffmann.ch	P. 9/13/25/35/63/67
Gärtner von Eden · www.gaertner-von-eden.de	P. 43
Hufschmid Gartenbau · www.hufschmid-gartenbau.ch	P. 4/13/15/33/49/55/63/67/68/69/70/87/90/91/96/97
istock.com · piovesempre	P. 43/60/129
istock.com · numismarty	P. 122
istock.com · andreaskrappweis	P. 126
istock.com · alvarez	P. 126
Jan Hauser AG · www.ausseneinrichter.ch	P. 8/13/28/45/47/69/123/128
Jonni Borgmann Rellingen · www.borgmann-garten.de	P. 93
Jürgen Becker, Gartendesign Manuel Sauer · www.terramanus.de	P. 59/76/77/79
LUCE Elektro AG · www.aqua-luce.ch	P. 29/33/55/59/68/70
Müller Gärtner von Eden · www.mueller-gartenbau.ch	P. 45/47/69/76/83
ROLF VON BURG · www.vonburg-gartenarchitektur.ch	P. 76
Seiler Gärten · www.seiler-gaerten.ch	P. 39/41/51/67/93
veranda viva · www.verandaviva.ch	P. 51/87

Concept & design: RIEGG Markenkommunikation, Neudrossenfeld/Germany, www.riegg.com

Production: RIEGG Markenkommunikation, Neudrossenfeld/Germany, www.riegg.com

Print: hofmann infocom GmbH



s.t.a.u.b *designlight ag*
The professional lighting system

staub designlight ag · unter Sagi 6 · CH – 6362 Stansstad
Tel. +41 (0)41 619 20 30 · info@staub-designlight.ch · www.staub-designlight.ch